

CF 20 SK INA

Cam followers

TYPE: Roller bearings, Stud type track rollers, With axial guidance, full complement bearing, gap seal on both side, cylindrical outer ring, hex socket, inch size

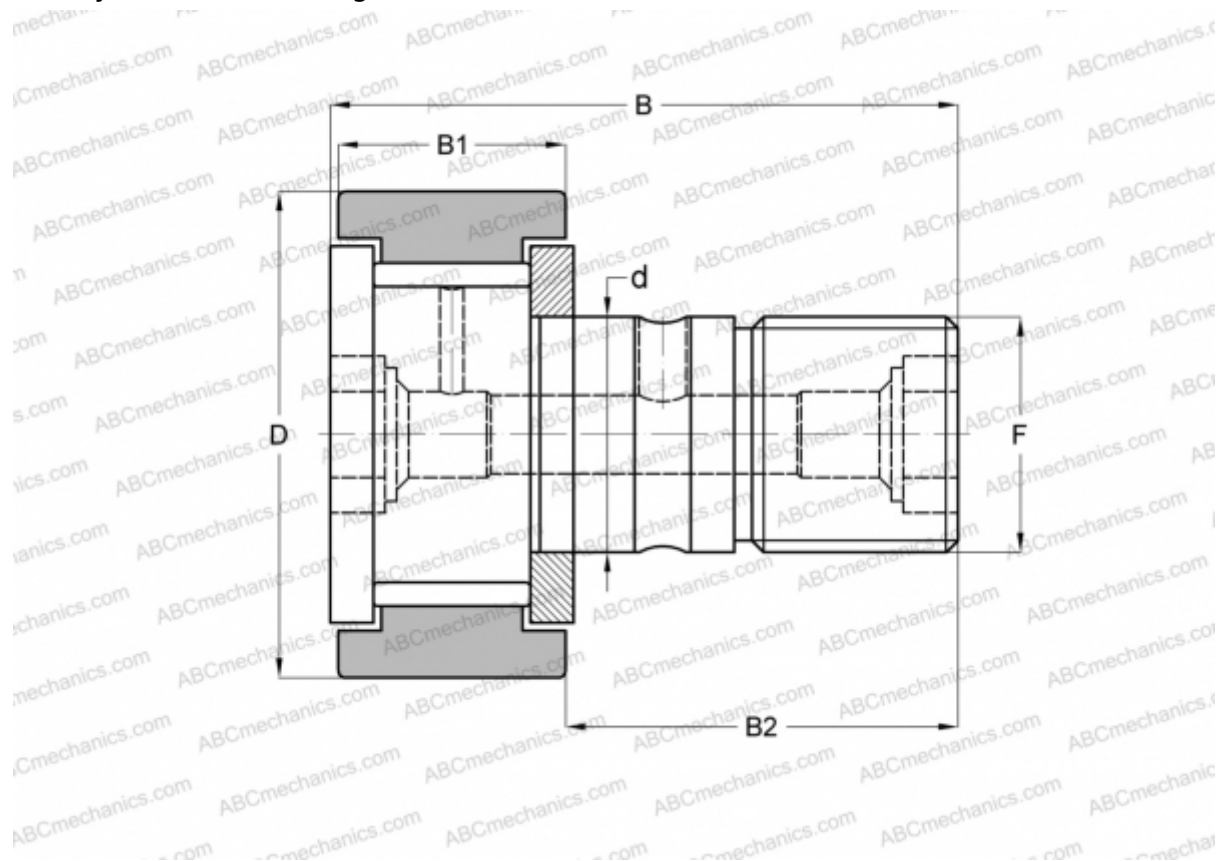

Technical specification

DIMENSIONS, MM

d	12,700
D	31,750
B	51,594
B1	19,844
B2	31,750
F	1/2-20

WEIGHT, KG 0,132

MANUFACTURER [INA](#)

INTERCHANGE

ABC	CR 20 VB
IKO	CR 20 VB
TORRINGTON	CRB-20
McGill	CF-1 1/4-B