

CRB-22 TORRINGTON

Cam followers

TYPE: Roller bearings, Stud type track rollers, With axial guidance, full complement bearing, gap seal on both side, cylindrical outer ring, hex socket, inch size

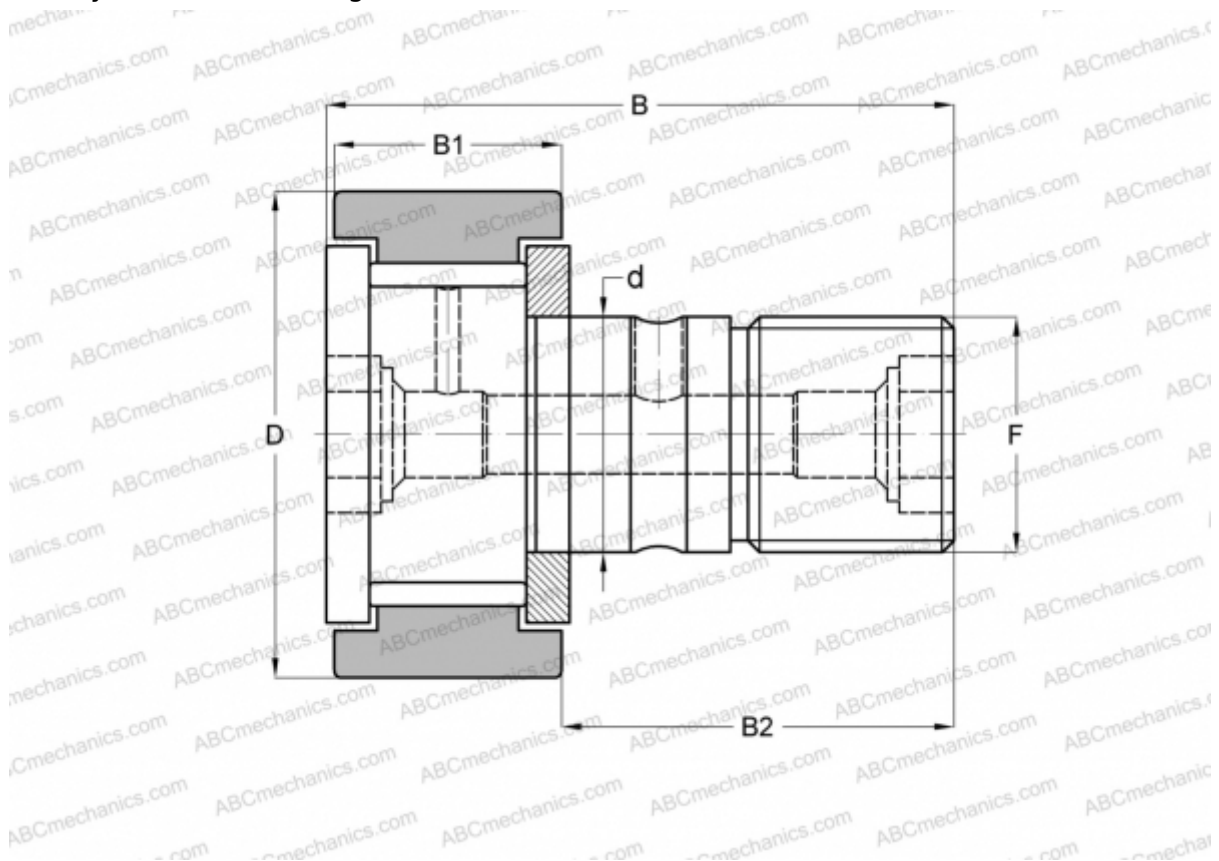

Technical specification

DIMENSIONS, MM

d	12,700
D	34,925
B	51,594
B1	19,844
B2	31,750
F	1/2-20

WEIGHT, KG 0,157

MANUFACTURER [TORRINGTON](#)

INTERCHANGE

ABC	CR 22 VB
IKO	CR 22 VB
INA	CF 22 SK
McGill	CF-1 3/8-B