

CF 28 SK INA

Cam followers

TYPE: Roller bearings, Stud type track rollers, With axial guidance, full complement bearing, gap seal on both side, cylindrical outer ring, hex socket, inch size

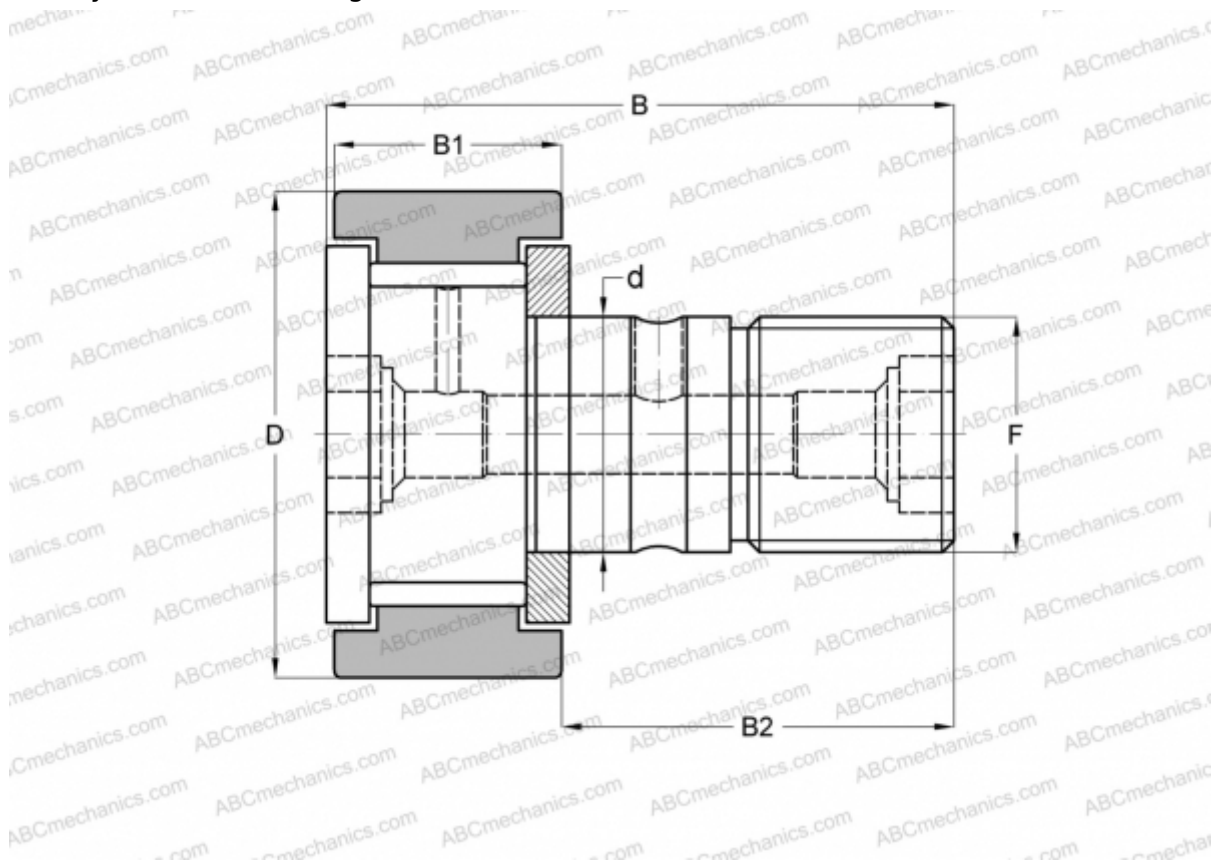

Technical specification

DIMENSIONS, MM

d	19,050
D	44,450
B	70,644
B1	26,194
B2	44,450
F	3/4-16

WEIGHT, KG 0,365

MANUFACTURER [INA](#)

INTERCHANGE

ABC	CR 28 VB
IKO	CR 28 VB
TORRINGTON	CRB-28
McGill	CF-1 3/4-B