

CR 30 VB ABC

Cam followers

TYPE: Roller bearings, Stud type track rollers, With axial guidance, full complement bearing, gap seal on both side, cylindrical outer ring, hex socket, inch size

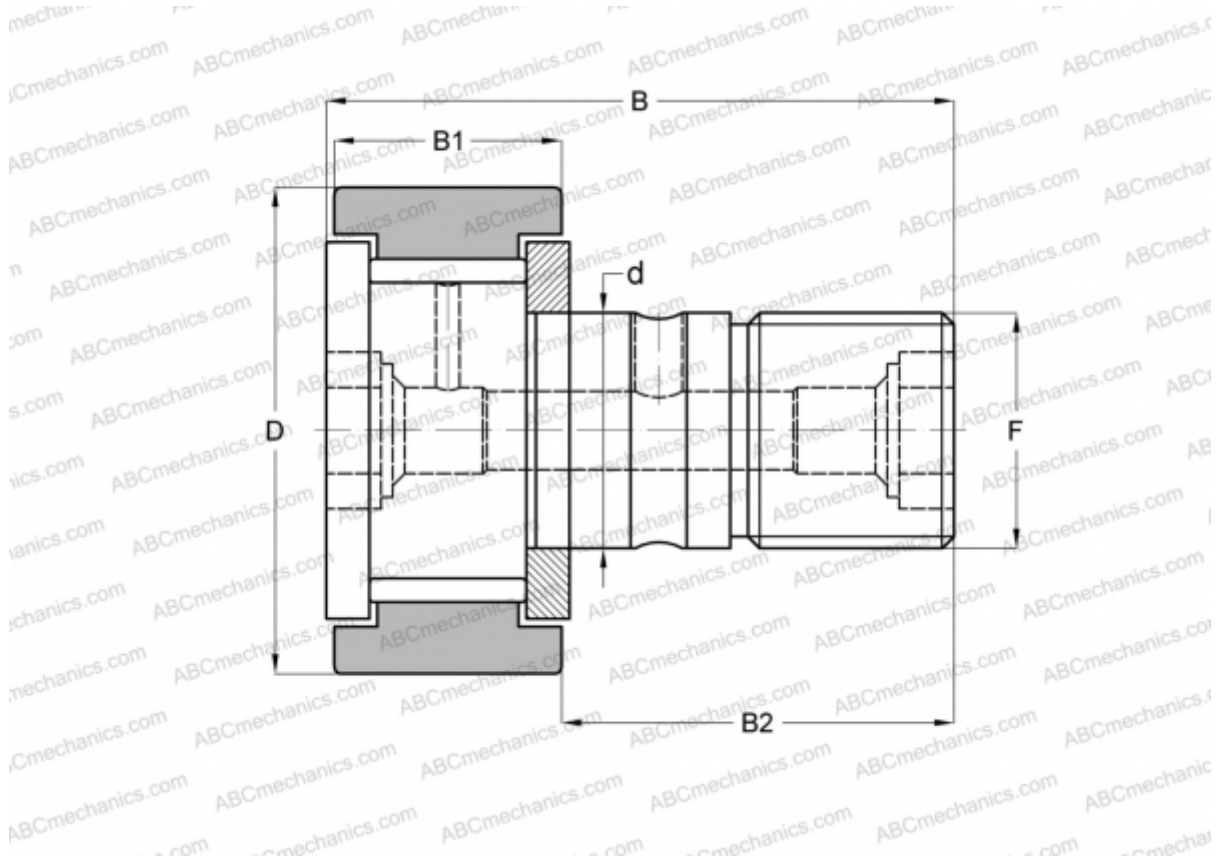

Technical specification

DIMENSIONS, MM

d	19,050
D	47,625
B	70,644
B1	26,194
B2	44,450
F	3/4-16

WEIGHT, KG 0,410

MANUFACTURER [ABC](#)

INTERCHANGE

IKO	CR 30 VB
TORRINGTON	CRB-30
INA	CF 30 SK
McGill	CF-1 7/8-B