

## CR 36 VB IKO

Cam followers

TYPE: Roller bearings, Stud type track rollers, With axial guidance, full complement bearing, gap seal on both side, cylindrical outer ring, hex socket, inch size

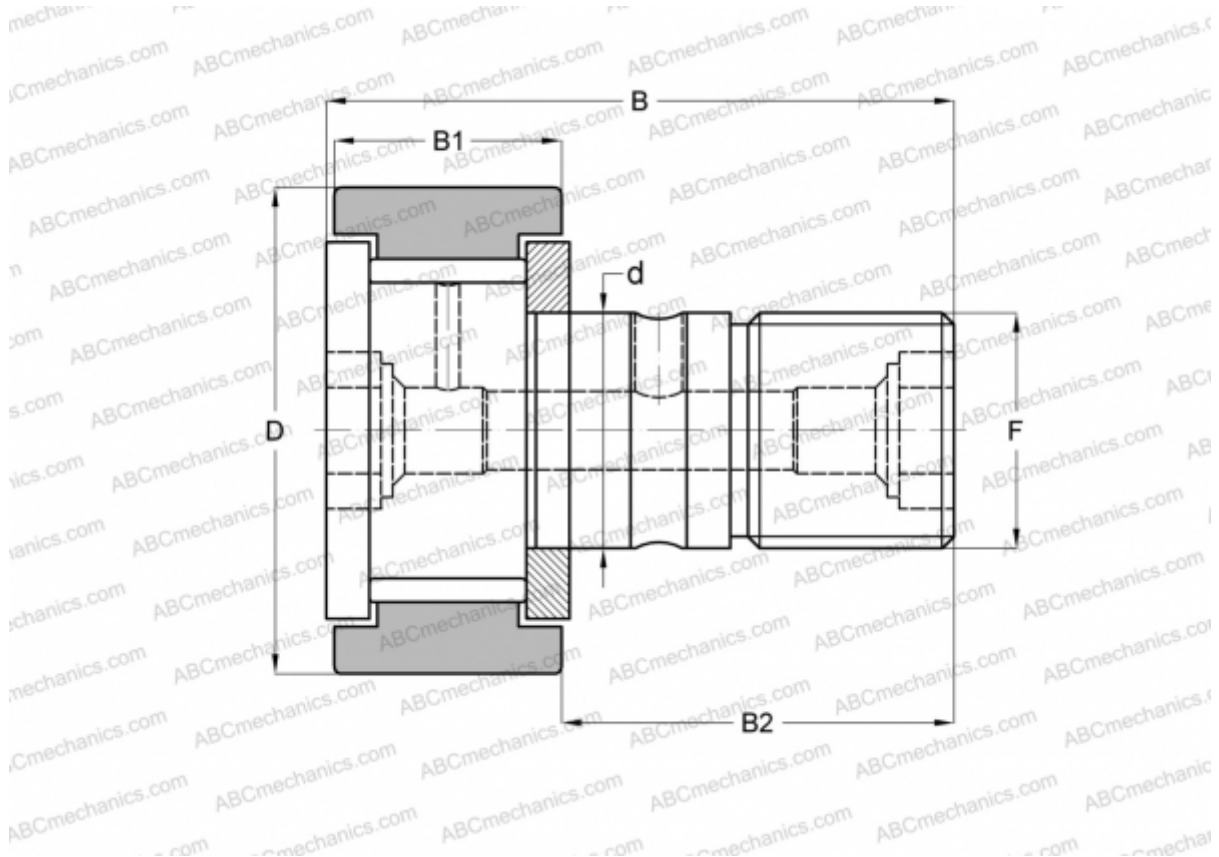

### Technical specification

#### DIMENSIONS, MM

d	22,225
D	57,150
B	83,344
B1	32,544
B2	50,800
F	7/8-14

**WEIGHT, KG** 0,750

**MANUFACTURER** [IKO](#)

#### INTERCHANGE

ABC	<a href="#">CR 36 VB</a>
TORRINGTON	<a href="#">CRB-36</a>
INA	<a href="#">CF 36 SK</a>
McGill	<a href="#">CF-2 1/4-B</a>

#### CALCULATION DATA

Basic dynamic load rating, C	45,700 kN
Basic static load rating, Co	80,600 kN