

## CF 18 Y INA

Cam followers

TYPE: Roller bearings, Stud type track rollers, With axial guidance, full complement bearing, gap seal on both side, inch size

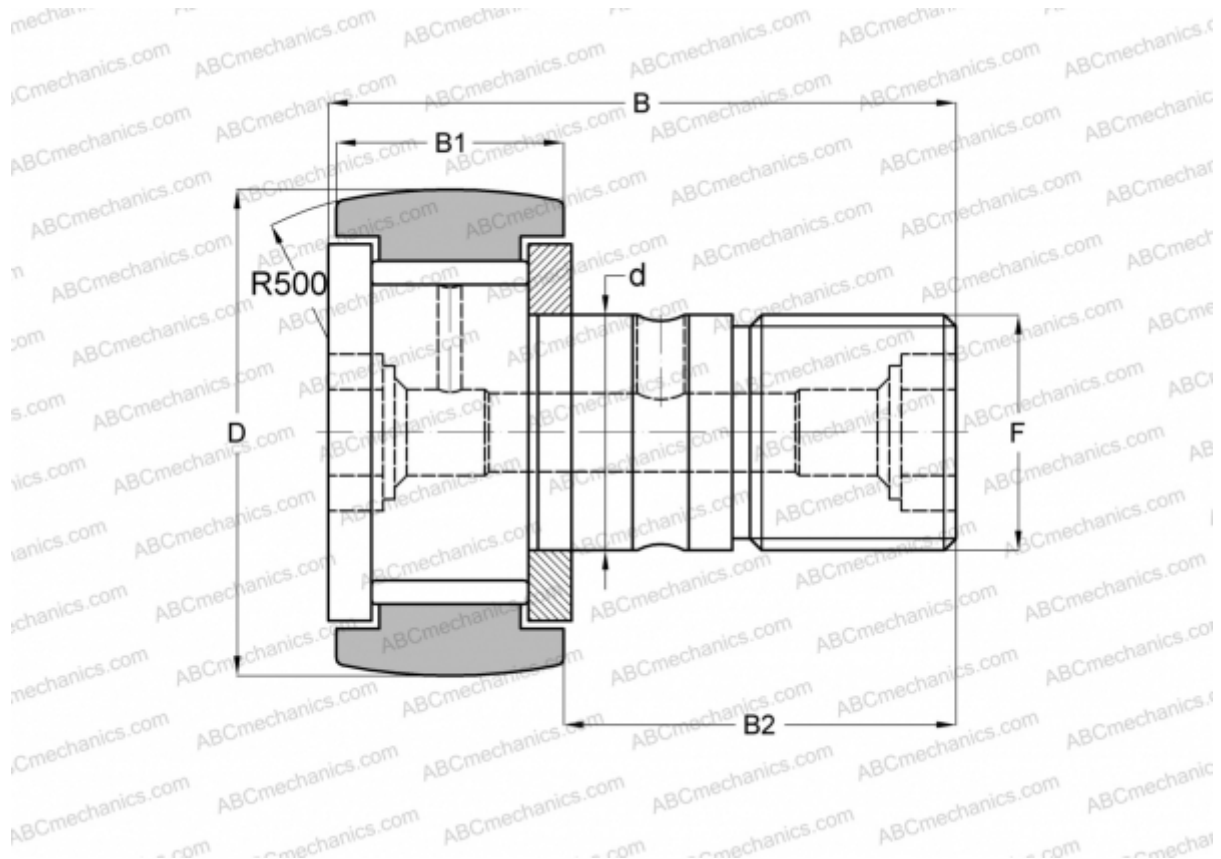

### Technical specification

#### DIMENSIONS, MM

d	11,112
D	28,575
B	42,069
B1	16,669
B2	25,400
F	7/16-20

**WEIGHT, KG** 0,088

**MANUFACTURER** [INA](#)

#### INTERCHANGE

ABC	<a href="#">CR 18 VR</a>
IKO	<a href="#">CR 18 VR</a>
TORRINGTON	<a href="#">CRC-18</a>
McGill	<a href="#">CCF-1 1/8</a>