

CF-1-SB McGill

Cam followers

TYPE: Roller bearings, Stud type track rollers, With axial guidance, full complement bearing, sealing rings on both sides, cylindrical outer ring, hex socket, inch size

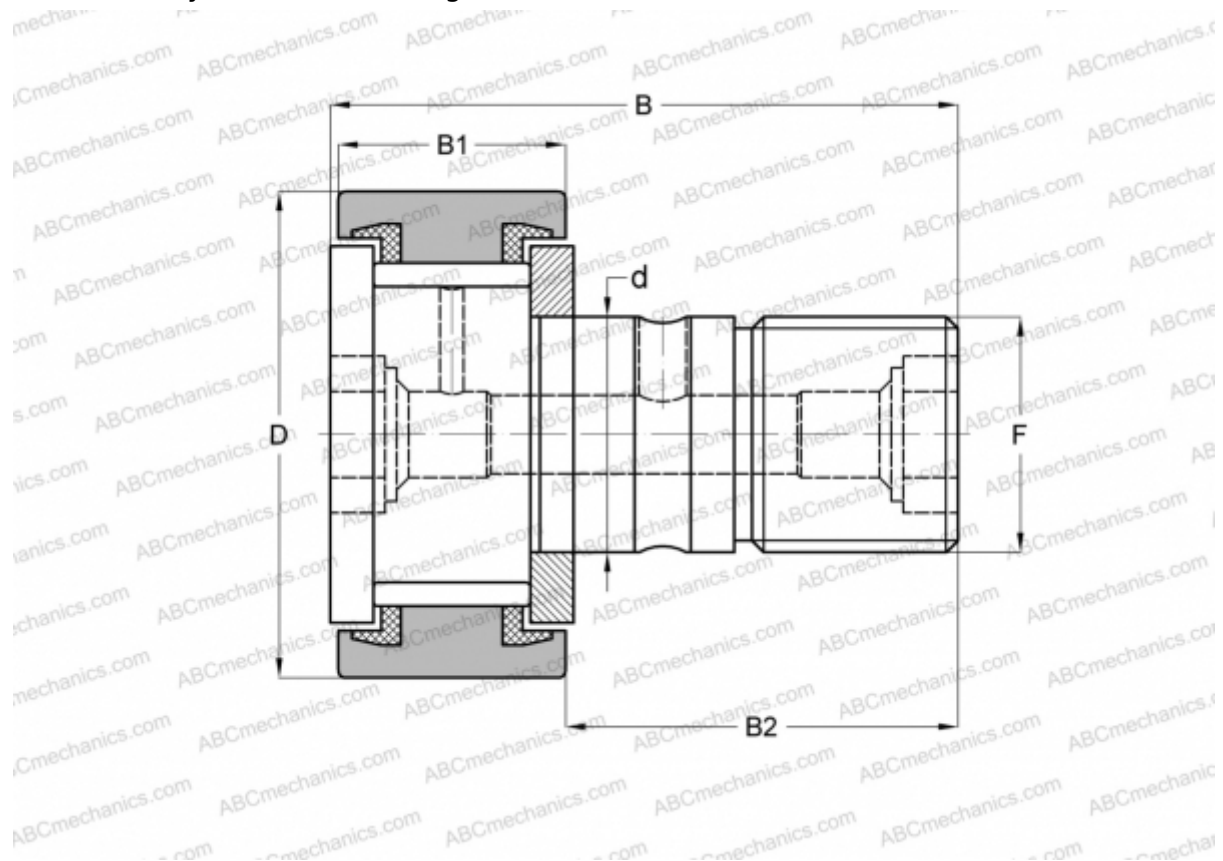

Technical specification

DIMENSIONS, MM

d	11,112
D	25,400
B	42,069
B1	16,669
B2	25,400
F	7/16-20

WEIGHT, KG 0,073

MANUFACTURER [McGill](#)

INTERCHANGE

ABC	CR16 VBUU
IKO	CR16 VBUU
TORRINGTON	CRSB-16
INA	CF 16 PPSK