

CRSB-18 TORRINGTON

Cam followers

TYPE: Roller bearings, Stud type track rollers, With axial guidance, full complement bearing, sealing rings on both sides, cylindrical outer ring, hex socket, inch size

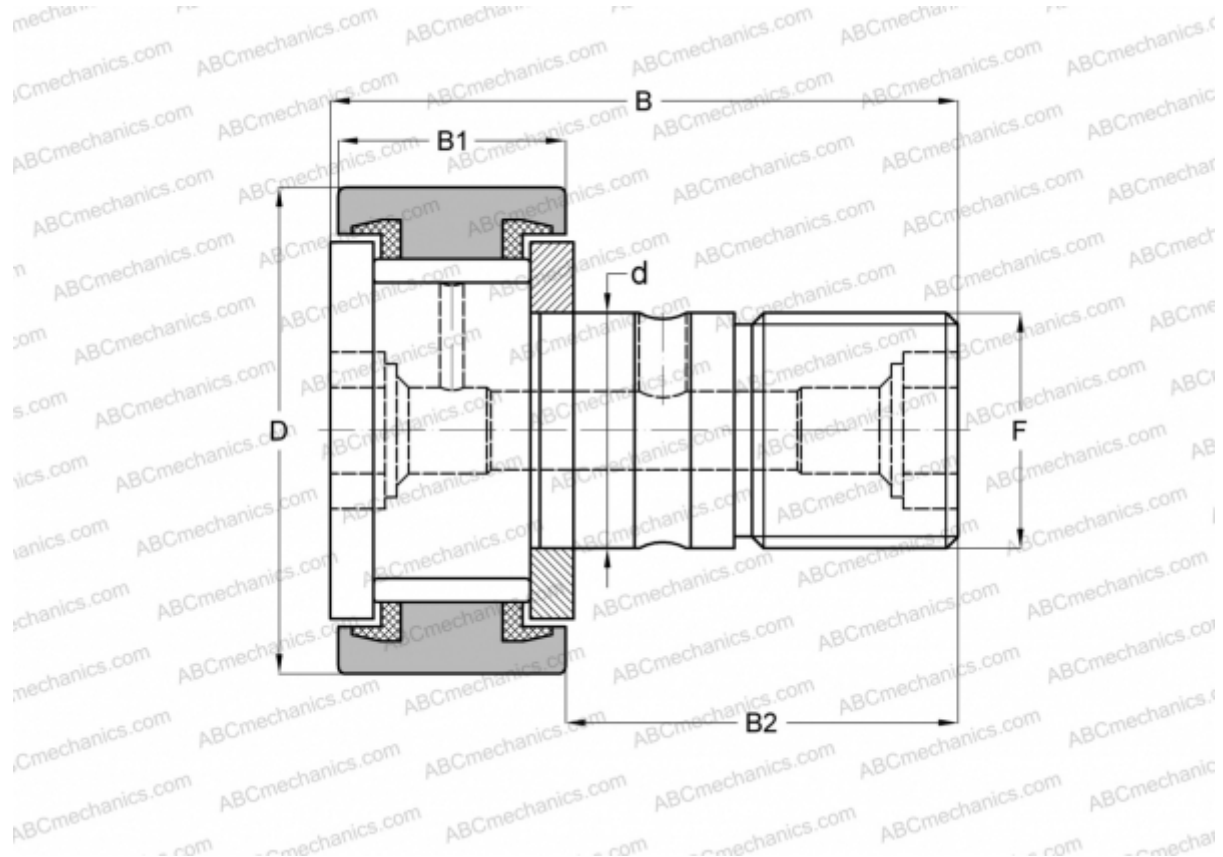

Technical specification

DIMENSIONS, MM

d	11,112
D	28,575
B	42,069
B1	16,669
B2	25,400
F	7/16-20

WEIGHT, KG 0,088

MANUFACTURER [TORRINGTON](#)

INTERCHANGE

ABC	CR 18 VBUU
IKO	CR 18 VBUU
INA	CF 18 PPSK
McGill	CF-1 1/8-SB