

CCF-1 1/2-S McGill

Cam followers

TYPE: Roller bearings, Stud type track rollers, With axial guidance, full complement bearing, sealing rings on both sides, inch size

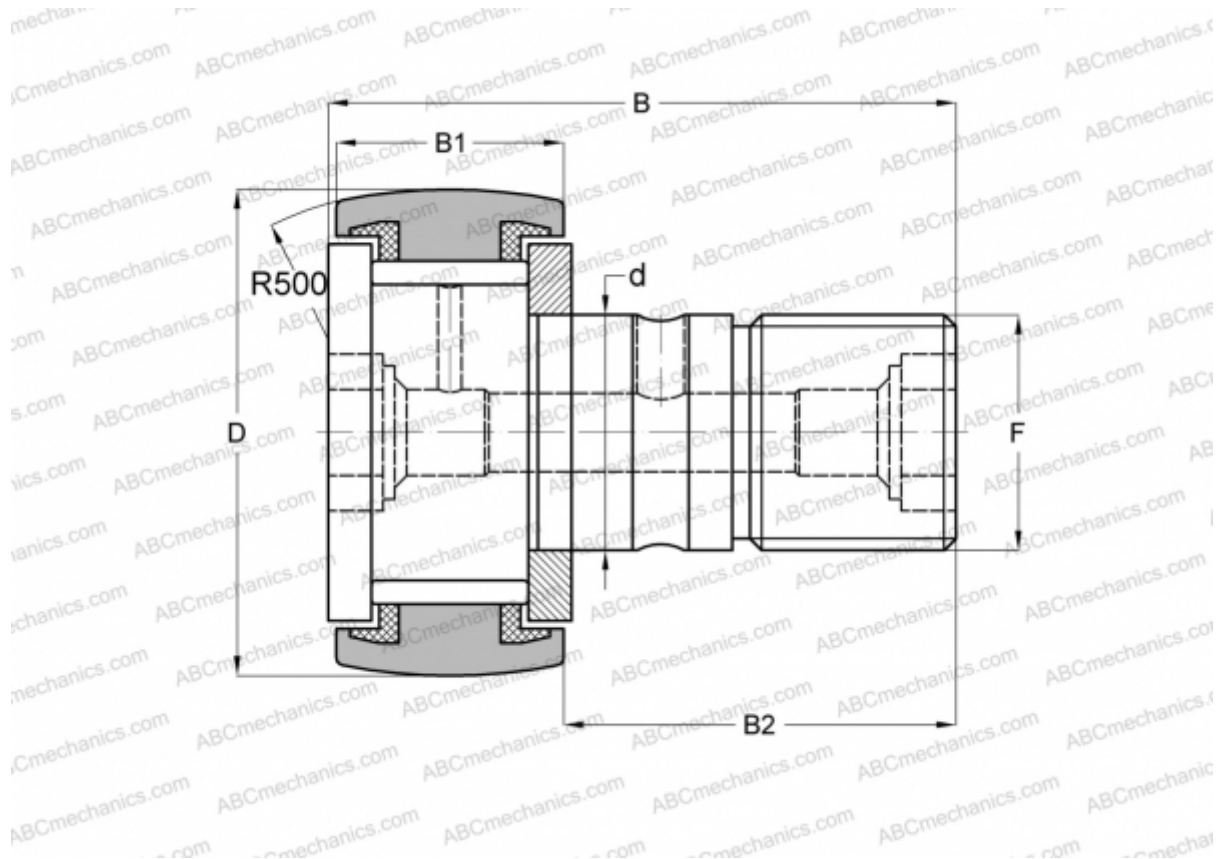

Technical specification

DIMENSIONS, MM

d	15,875
D	38,100
B	61,119
B1	23,019
B2	38,100
F	5/8-18

WEIGHT, KG 0,225

MANUFACTURER [McGill](#)

INTERCHANGE

ABC	CR 24 VUUR
IKO	CR 24 VUUR
TORRINGTON	CRSC-24
INA	CF 24 PPY