

## CR 26 VUUR IKO

Cam followers

TYPE: Roller bearings, Stud type track rollers, With axial guidance, full complement bearing, sealing rings on both sides, inch size

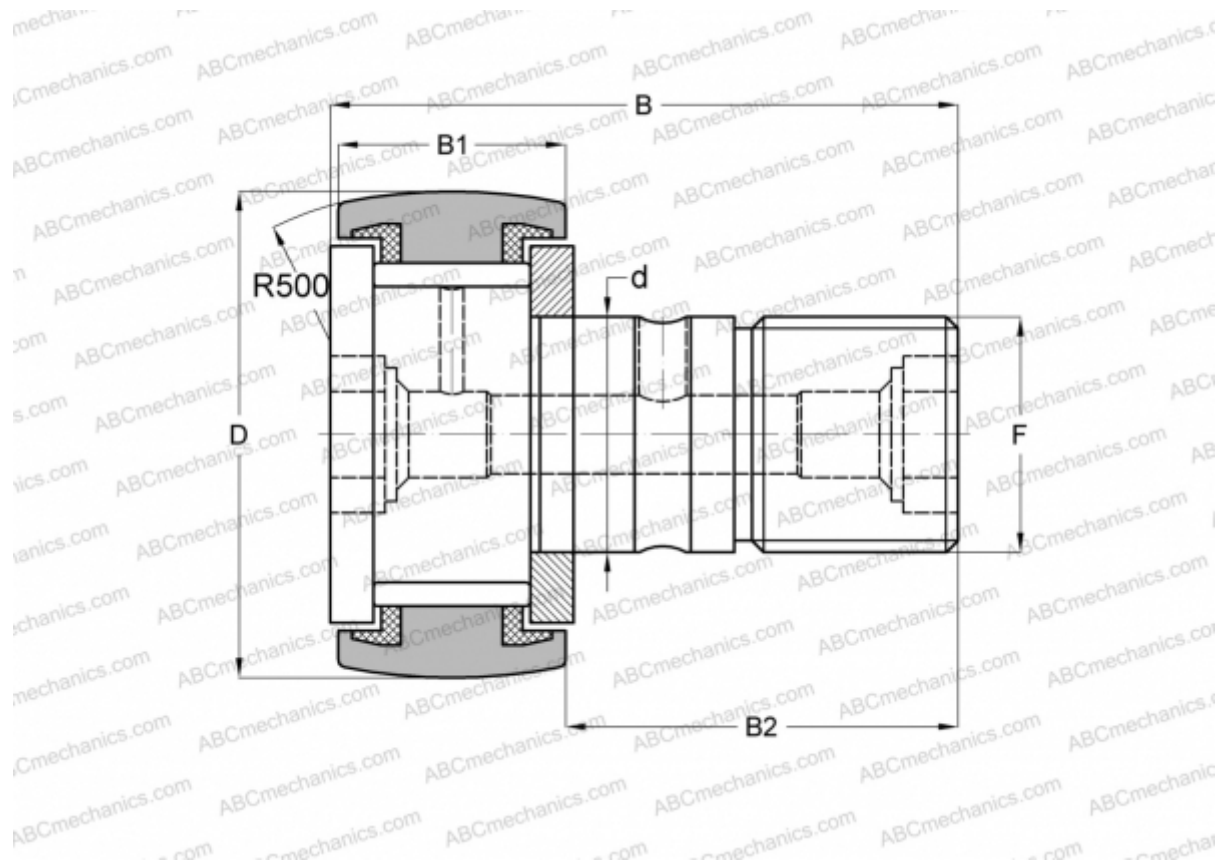

### Technical specification

#### DIMENSIONS, MM

d	15,875
D	41,275
B	61,119
B1	23,019
B2	38,100
F	5/8-18

**WEIGHT, KG** 0,260

**MANUFACTURER** [IKO](#)

#### INTERCHANGE

ABC	<a href="#">CR 26 VUUR</a>
TORRINGTON	<a href="#">CRSC-26</a>
INA	<a href="#">CF 26 PPY</a>
McGill	<a href="#">CCF-1 5/8-S</a>

#### CALCULATION DATA

Basic dynamic load rating, C	28,200 kN
Basic static load rating, Co	40,100 kN