

CF 32 PPY INA

Cam followers

TYPE: Roller bearings, Stud type track rollers, With axial guidance, full complement bearing, sealing rings on both sides, inch size

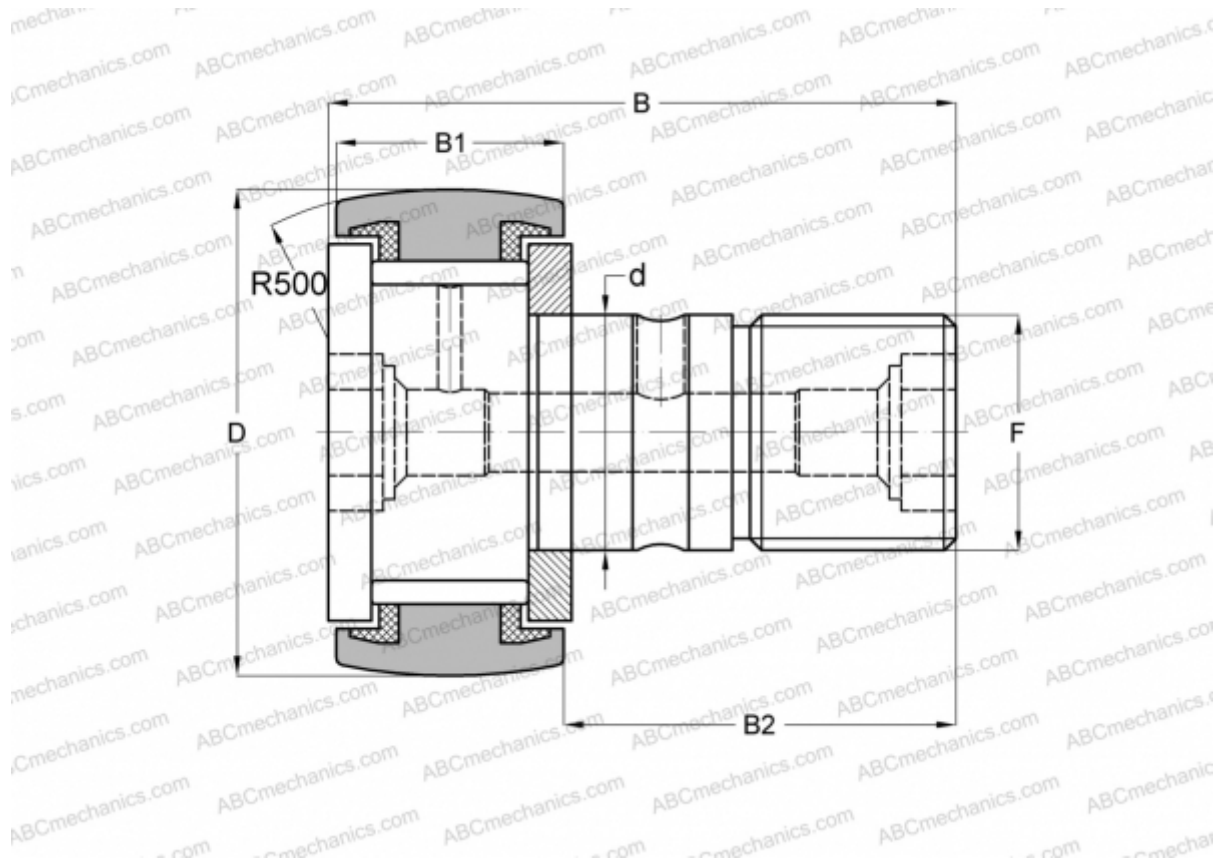

Technical specification

DIMENSIONS, MM

d	22,225
D	50,800
B	83,344
B1	32,544
B2	50,800
F	7/8-14

WEIGHT, KG 0,615

MANUFACTURER [INA](#)

INTERCHANGE

ABC	CR 32 VUUR
IKO	CR 32 VUUR
TORRINGTON	CRSC-32
McGill	CCF-2-S