

CR 36 VUUR IKO

Cam followers

TYPE: Roller bearings, Stud type track rollers, With axial guidance, full complement bearing, sealing rings on both sides, inch size

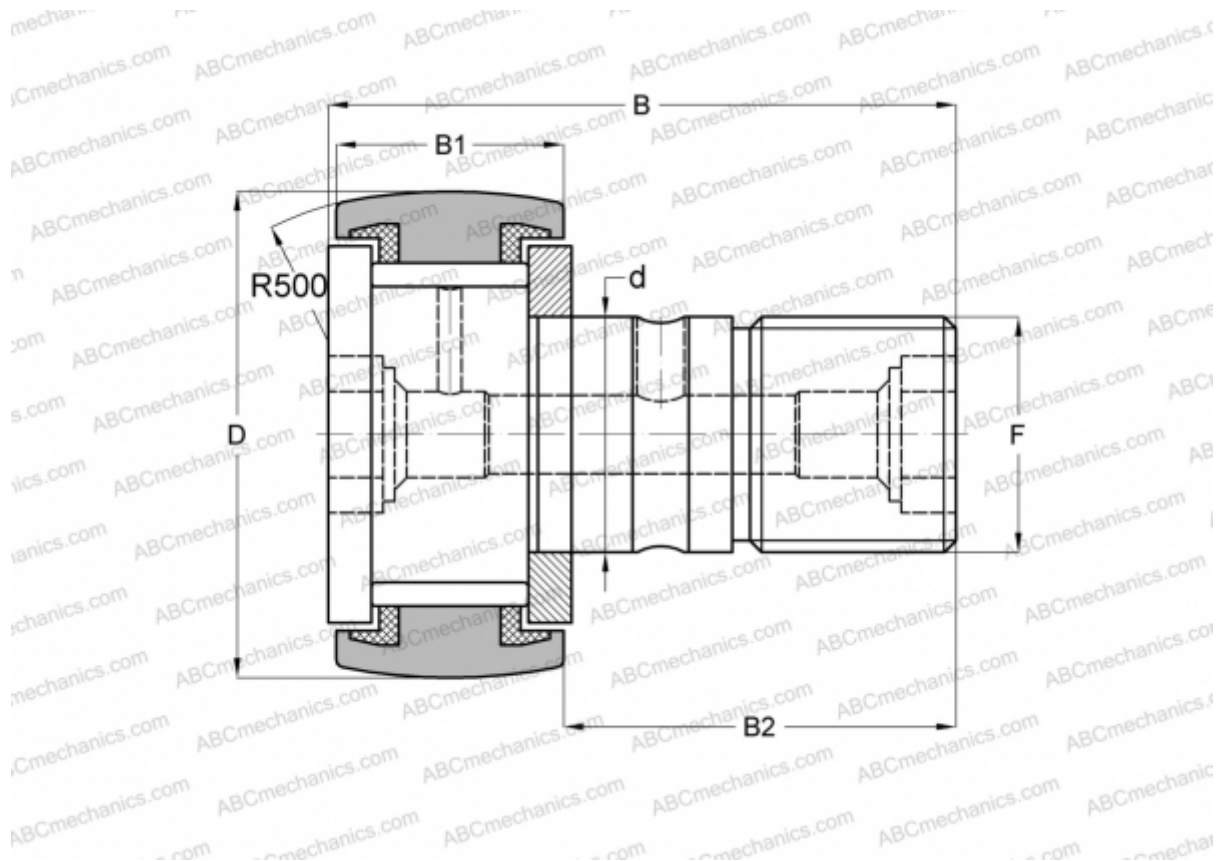

Technical specification

DIMENSIONS, MM

d	22,225
D	57,150
B	83,344
B1	32,544
B2	50,800
F	7/8-14

WEIGHT, KG 0,750

MANUFACTURER [IKO](#)

INTERCHANGE

ABC	CR 36 VUUR
TORRINGTON	CRSC-36
INA	CF 36 PPY
McGill	CCF-2 1/4-S

CALCULATION DATA

Basic dynamic load rating, C	45,700 kN
Basic static load rating, Co	80,600 kN