

CF 12 PP INA

Cam followers

TYPE: Roller bearings, Stud type track rollers, With axial guidance, full complement bearing, sealing rings on both sides, cylindrical outer ring, inch size

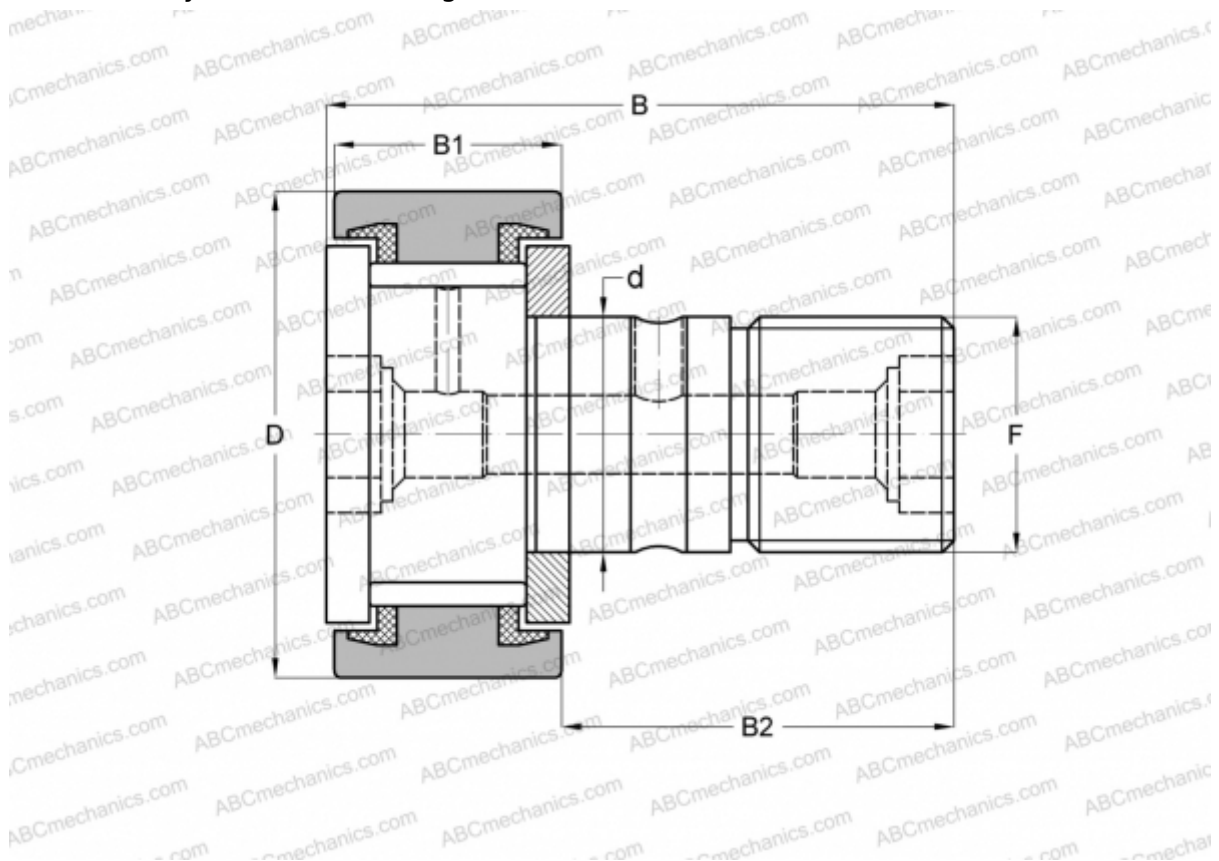

Technical specification

DIMENSIONS, MM

d	9,525
D	19,050
B	35,719
B1	13,494
B2	22,225
F	3/8-24

WEIGHT, KG 0,035

MANUFACTURER [INA](#)

INTERCHANGE

ABC	CR 12 VUU
IKO	CR 12 VUU
TORRINGTON	CRS-12
McGill	CF-3/4-S