

CR 14 VUU IKO

Cam followers

TYPE: Roller bearings, Stud type track rollers, With axial guidance, full complement bearing, sealing rings on both sides, cylindrical outer ring, inch size

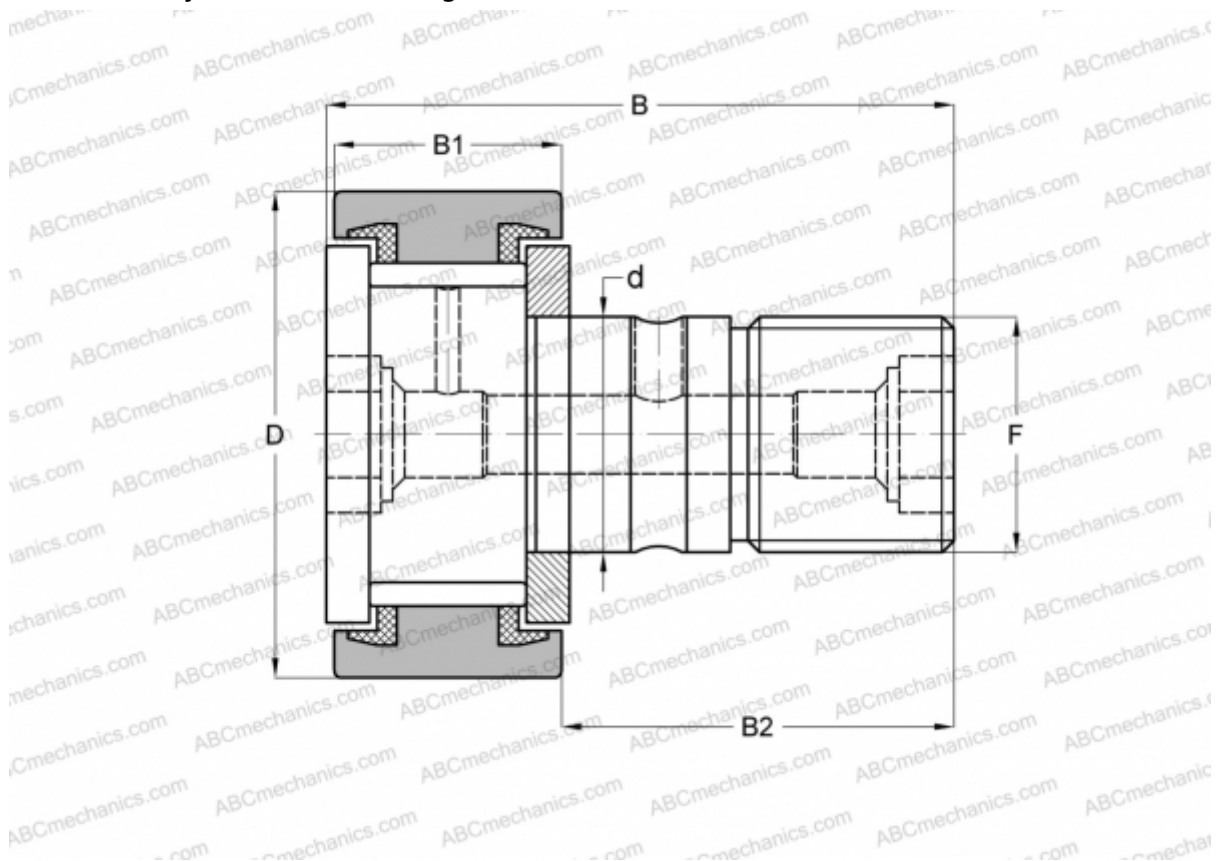

Technical specification

DIMENSIONS, MM

d	9,525
D	22,225
B	35,719
B1	13,494
B2	22,225
F	3/8-24

WEIGHT, KG 0,046

MANUFACTURER [IKO](#)

INTERCHANGE

ABC	CR 14 VUU
TORRINGTON	CRS-14
INA	CF 14 PP
McGill	CF-7/8-S

CALCULATION DATA

Basic dynamic load rating, C	8,710 kN
Basic static load rating, Co	12,300 kN