

CRS-14 TORRINGTON

Cam followers

TYPE: Roller bearings, Stud type track rollers, With axial guidance, full complement bearing, sealing rings on both sides, cylindrical outer ring, inch size

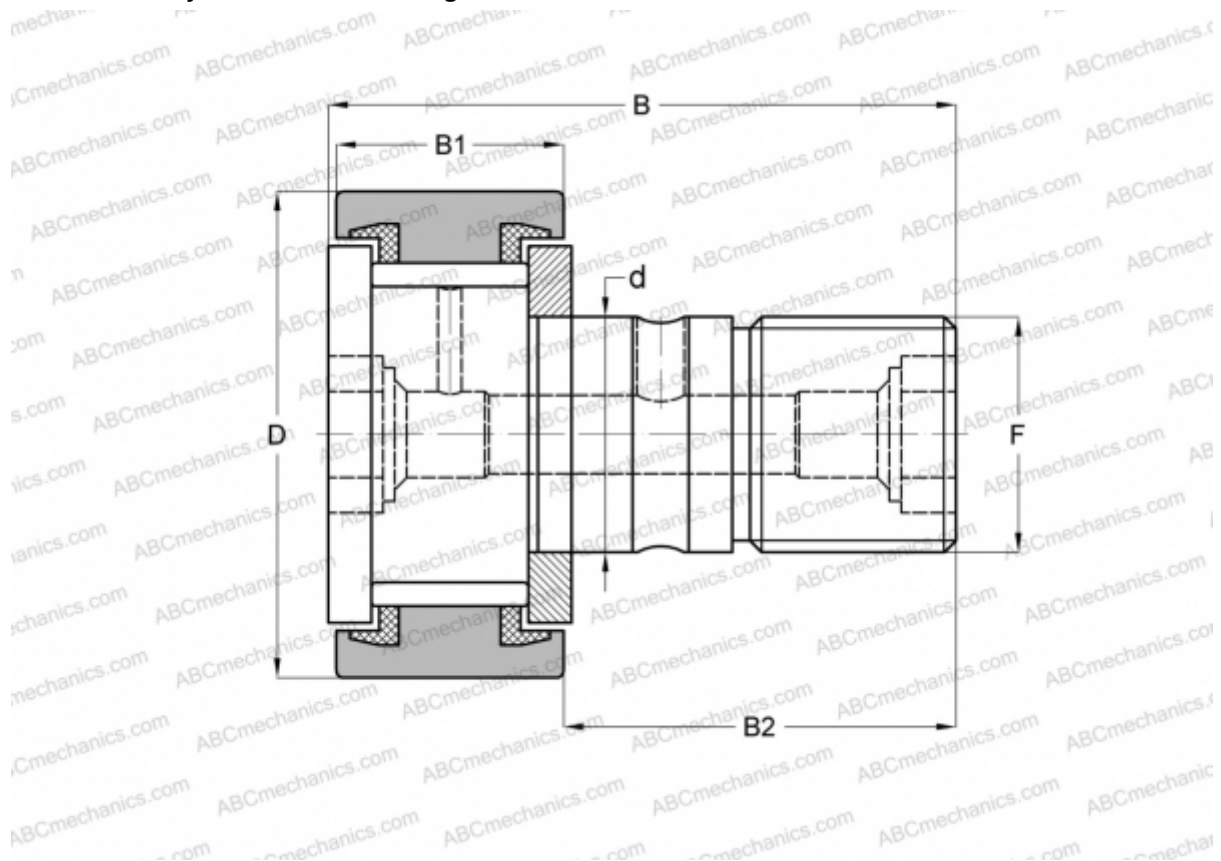

Technical specification

DIMENSIONS, MM

d	9,525
D	22,225
B	35,719
B1	13,494
B2	22,225
F	3/8-24

WEIGHT, KG 0,046

MANUFACTURER [TORRINGTON](#)

INTERCHANGE

ABC	CR 14 VUU
IKO	CR 14 VUU
INA	CF 14 PP
McGill	CF-7/8-S