

CF-1 3/8-S McGill

Cam followers

TYPE: Roller bearings, Stud type track rollers, With axial guidance, full complement bearing, sealing rings on both sides, cylindrical outer ring, inch size

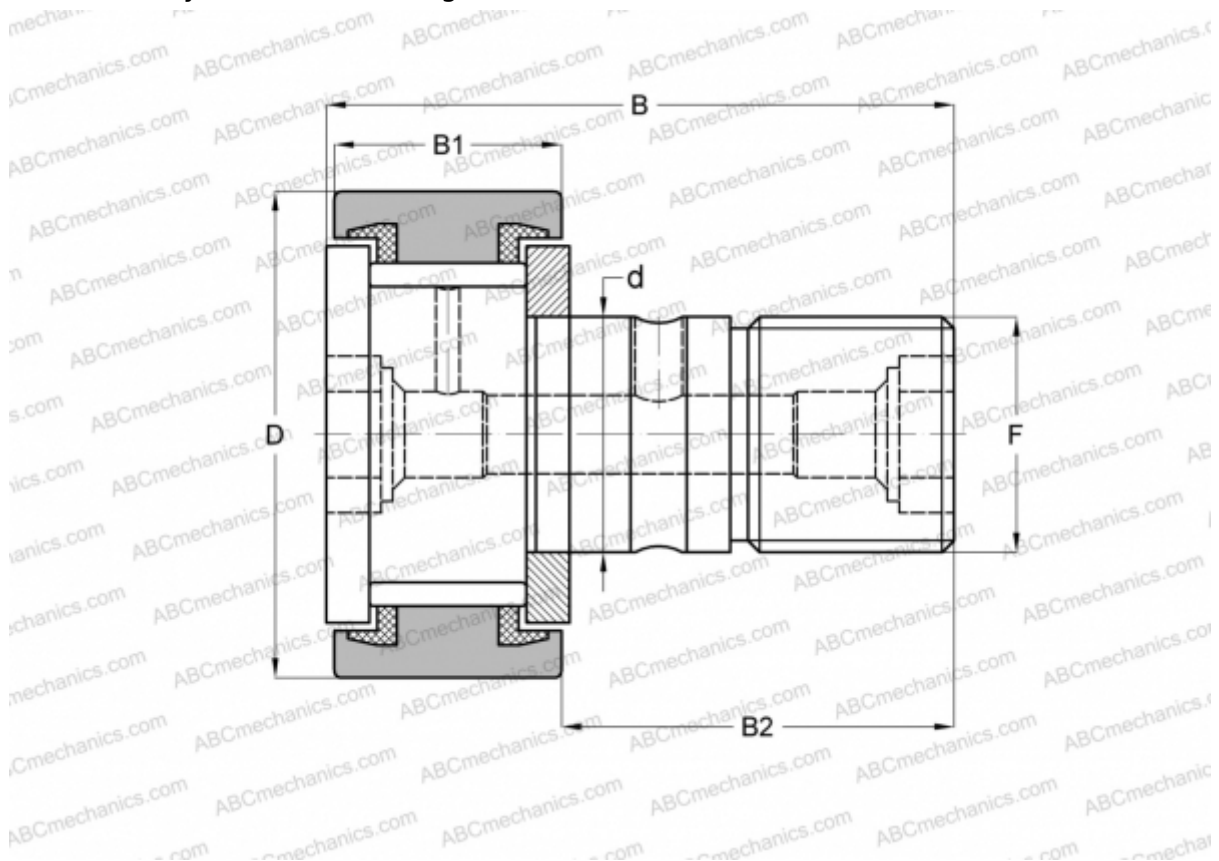

Technical specification

DIMENSIONS, MM

d	12,700
D	34,925
B	51,594
B1	19,844
B2	31,750
F	1/2-20

WEIGHT, KG 0,157

MANUFACTURER [McGill](#)

INTERCHANGE

ABC	CR 22 VUU
IKO	CR 22 VUU
TORRINGTON	CRS-22
INA	CF 22 PP