

## CR 28 VUU IKO

Cam followers

TYPE: Roller bearings, Stud type track rollers, With axial guidance, full complement bearing, sealing rings on both sides, cylindrical outer ring, inch size

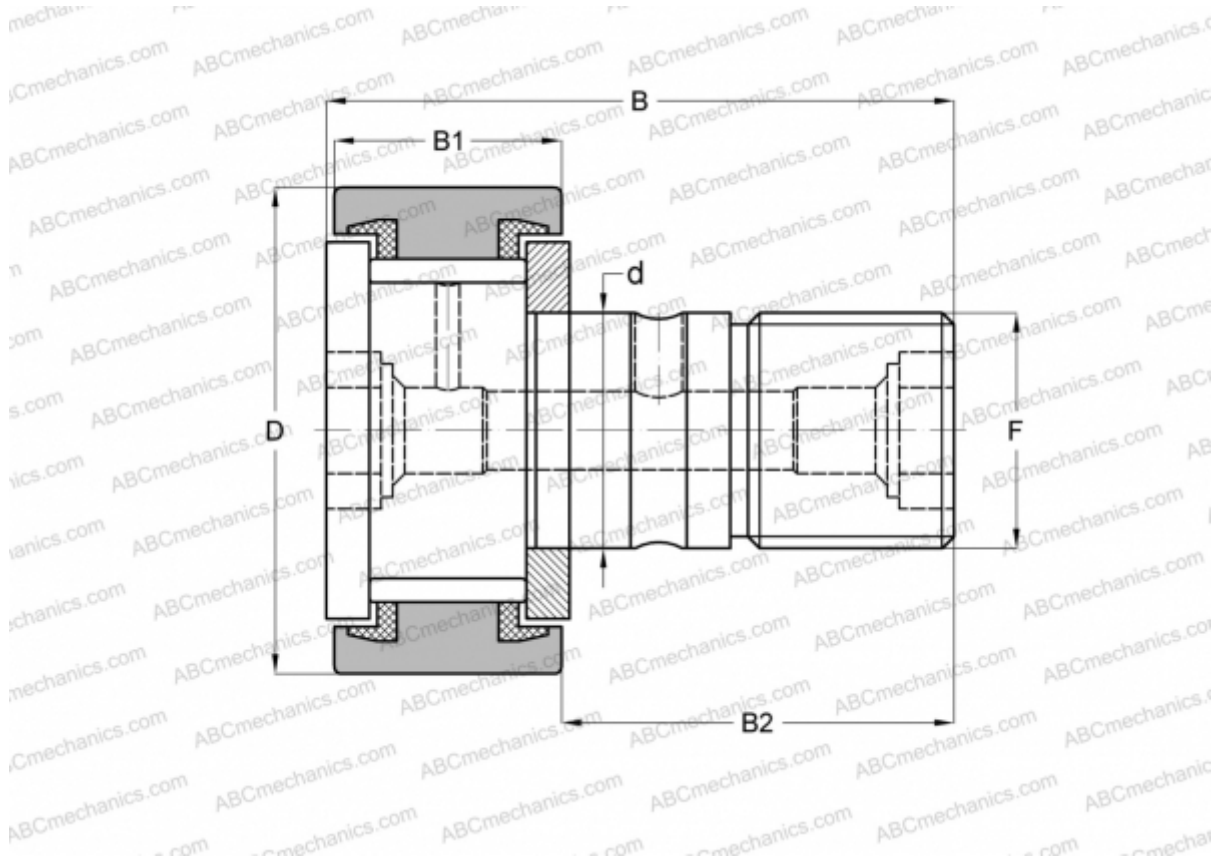

### Technical specification

#### DIMENSIONS, MM

d	19,050
D	44,450
B	70,644
B1	26,194
B2	44,450
F	3/4-16

**WEIGHT, KG** 0,365

**MANUFACTURER** [IKO](#)

#### INTERCHANGE

ABC	<a href="#">CR 28 VUU</a>
TORRINGTON	<a href="#">CRS-28</a>
INA	<a href="#">CF 28 PP</a>
McGill	<a href="#">CF-1 3/4-S</a>

#### CALCULATION DATA

Basic dynamic load rating, C	35,300 kN
Basic static load rating, Co	55,600 kN