

CR 36 VUU ABC

Cam followers

TYPE: Roller bearings, Stud type track rollers, With axial guidance, full complement bearing, sealing rings on both sides, cylindrical outer ring, inch size

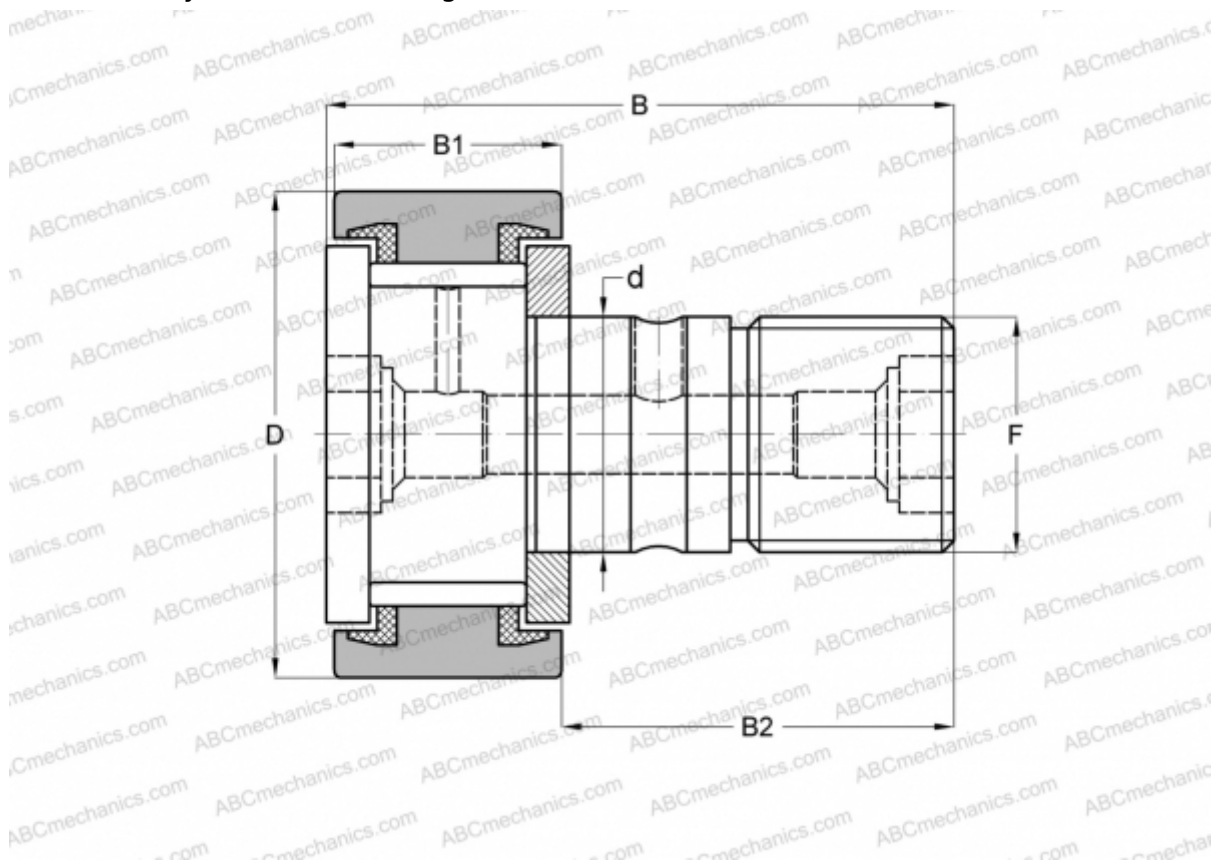

Technical specification

DIMENSIONS, MM

d	22,225
D	57,150
B	83,344
B1	32,544
B2	50,800
F	7/8-14

WEIGHT, KG 0,750

MANUFACTURER [ABC](#)

INTERCHANGE

IKO	CR 36 VUU
TORRINGTON	CRS-36
INA	CF 36 PP
McGill	CF-2 1/4-S