

## CRH 12 V(B)R ABC

Cam followers

TYPE: Roller bearings, Stud type track rollers, With axial guidance, full complement bearing, gap seal on both side, hex socket, heavy duty, inch size

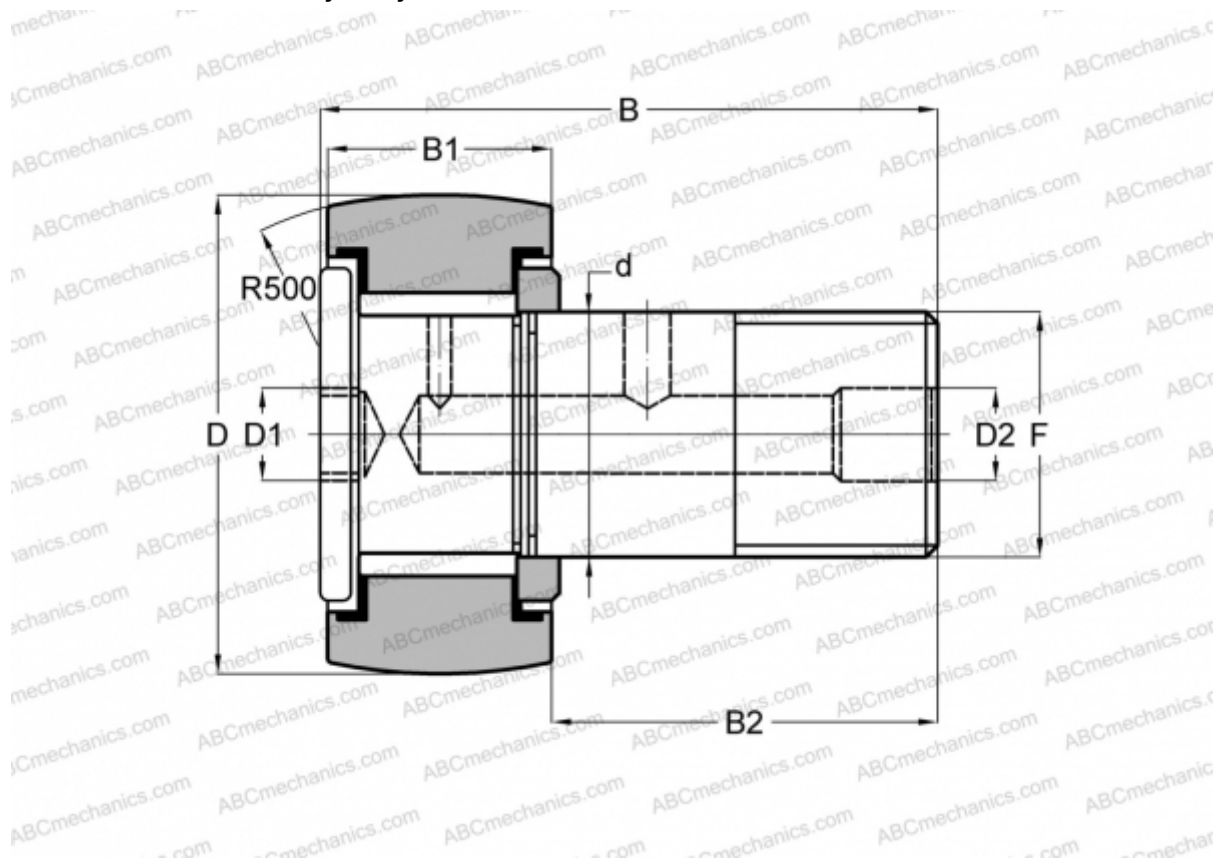

### Technical specification

#### DIMENSIONS, MM

d	11,112
D	19,050
B	36,700
B1	14,600
B2	22,100
F	7/16-20

**WEIGHT, KG** 0,039

**MANUFACTURER** [ABC](#)

#### INTERCHANGE

IKO	<a href="#">CRH 12 V(B)R</a>
McGill	<a href="#">CFH 3/4 (B)</a>