

CFH 3/4 (B) McGill

Cam followers

TYPE: Roller bearings, Stud type track rollers, With axial guidance, full complement bearing, gap seal on both side, hex socket, heavy duty, inch size

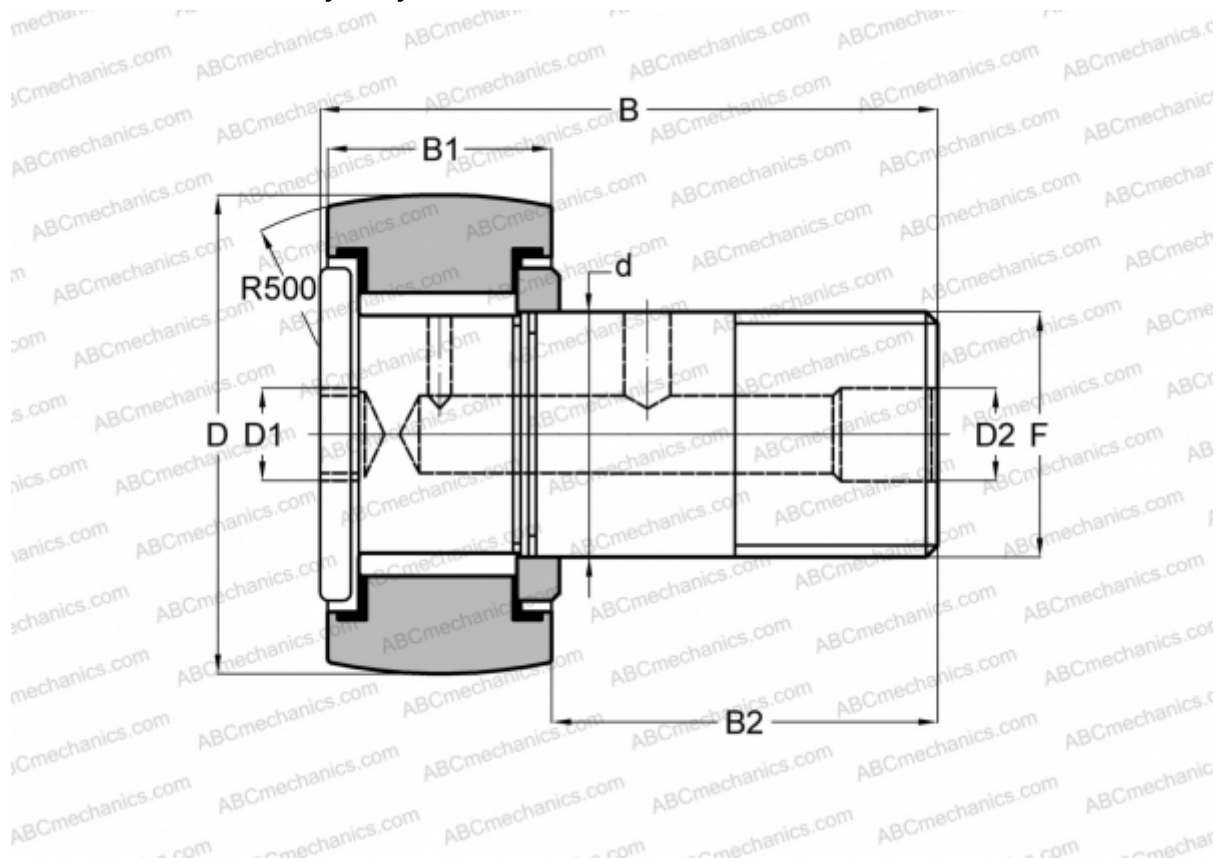

Technical specification

DIMENSIONS, MM

d	11,112
D	19,050
B	36,700
B1	14,600
B2	22,100
F	7/16-20

WEIGHT, KG 0,039

MANUFACTURER [McGill](#)

INTERCHANGE

ABC	CRH 12 V(B)R
IKO	CRH 12 V(B)R