

CRH 20 V(B)R ABC

Cam followers

TYPE: Roller bearings, Stud type track rollers, With axial guidance, full complement bearing, gap seal on both side, hex socket, heavy duty, inch size

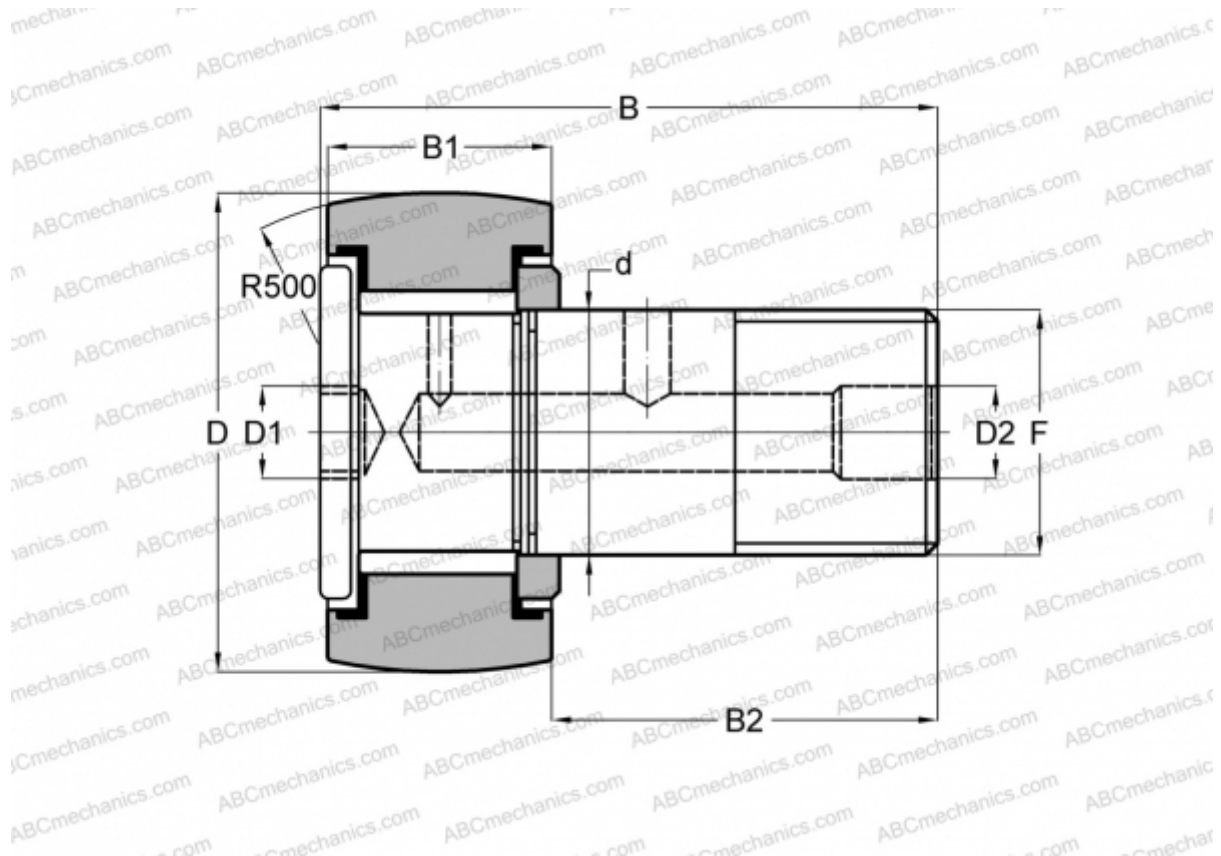

Technical specification

DIMENSIONS, MM

d	19,050
D	31,750
B	49,660
B1	21,000
B2	28,660
F	3/4-16

WEIGHT, KG 0,176

MANUFACTURER [ABC](#)

INTERCHANGE

IKO	CRH 20 V(B)R
McGill	CFH 1 1/4 (B)