

CRH 24 V(B)R ABC

Cam followers

TYPE: Roller bearings, Stud type track rollers, With axial guidance, full complement bearing, gap seal on both side, hex socket, heavy duty, inch size

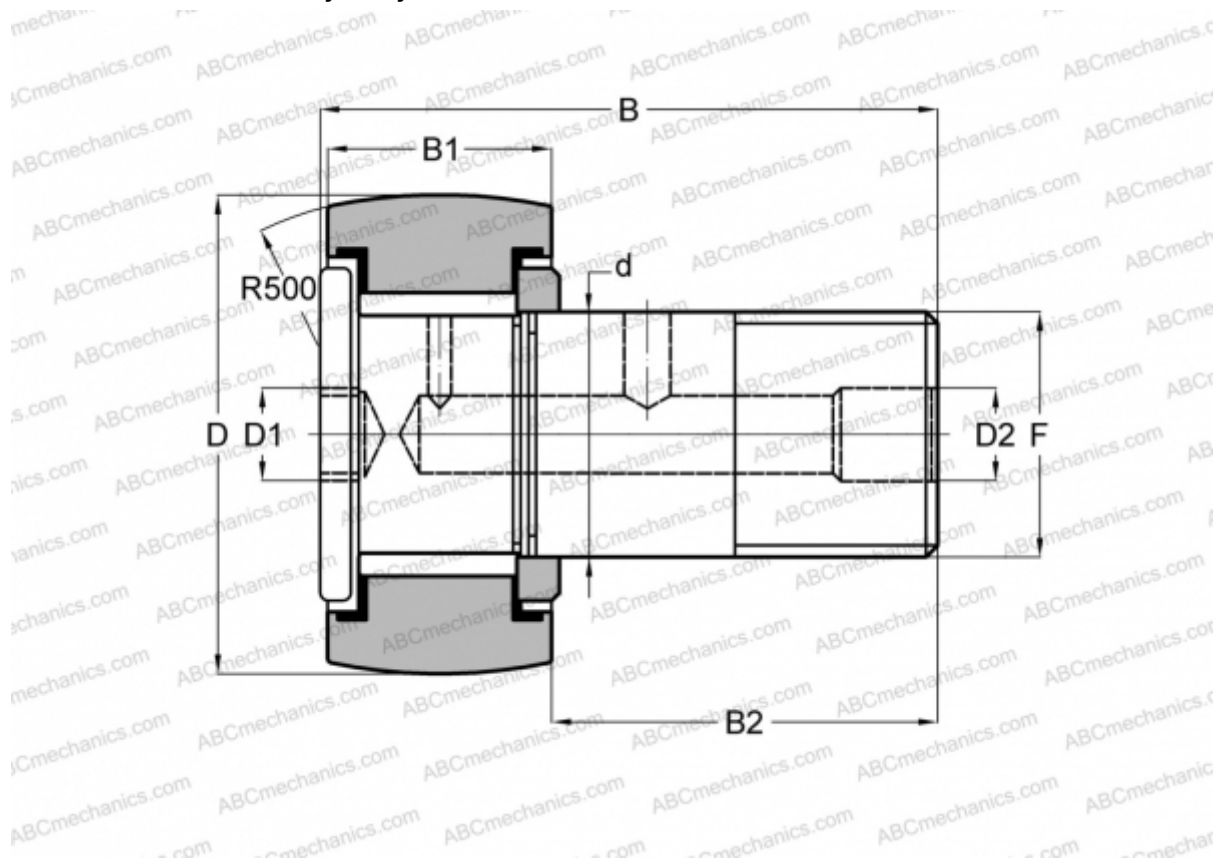

Technical specification

DIMENSIONS, MM

d	22,225
D	38,100
B	62,480
B1	24,300
B2	38,180
F	7/8-14

WEIGHT, KG 0,296

MANUFACTURER [ABC](#)

INTERCHANGE

IKO	CRH 24 V(B)R
McGill	CFH 1 1/2 (B)