

CFH 1 5/8 (B) McGill

Cam followers

TYPE: Roller bearings, Stud type track rollers, With axial guidance, full complement bearing, gap seal on both side, hex socket, heavy duty, inch size

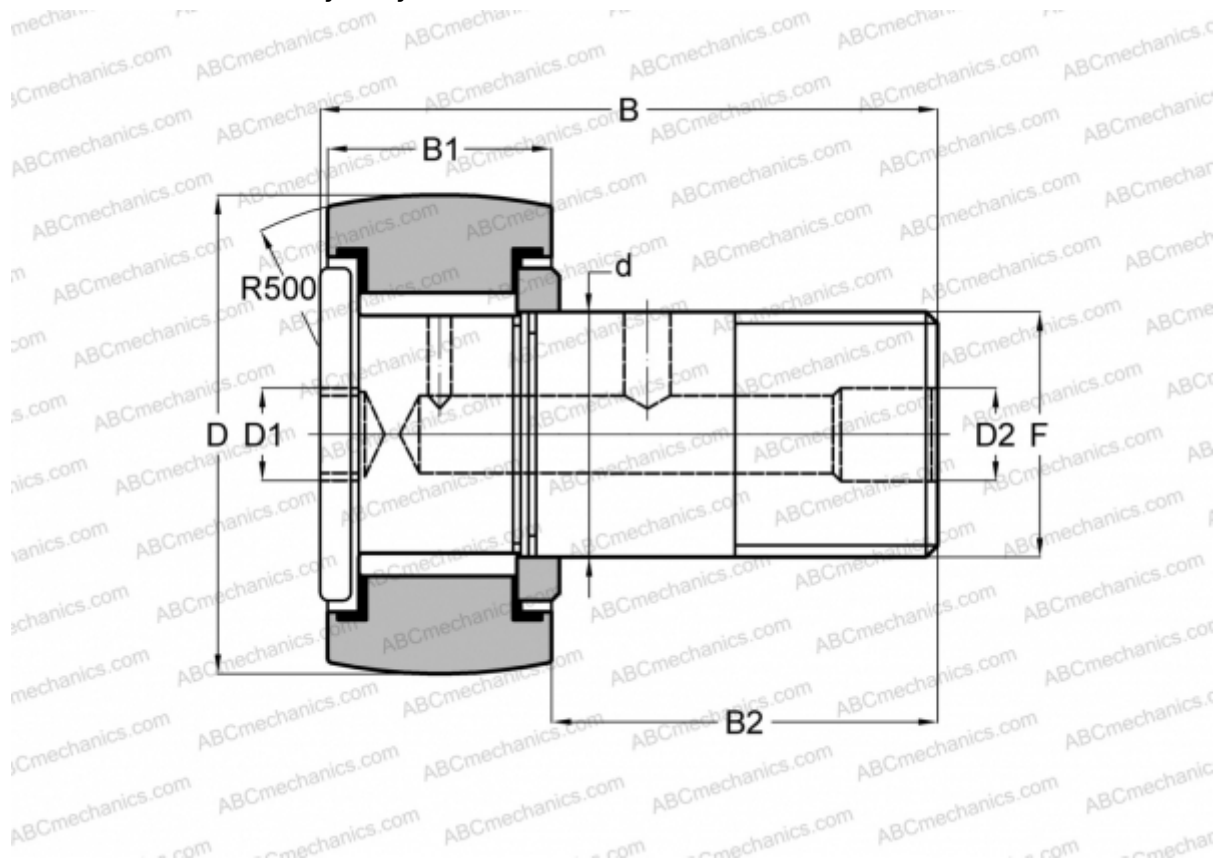

Technical specification

DIMENSIONS, MM

d	22,225
D	41,275
B	62,480
B1	24,300
B2	38,180
F	7/8-14

WEIGHT, KG 0,329

MANUFACTURER [McGill](#)

INTERCHANGE

ABC	CRH 26 V(B)R
IKO	CRH 26 V(B)R