

CRH 36 V(B)R ABC

Cam followers

TYPE: Roller bearings, Stud type track rollers, With axial guidance, full complement bearing, gap seal on both side, hex socket, heavy duty, inch size

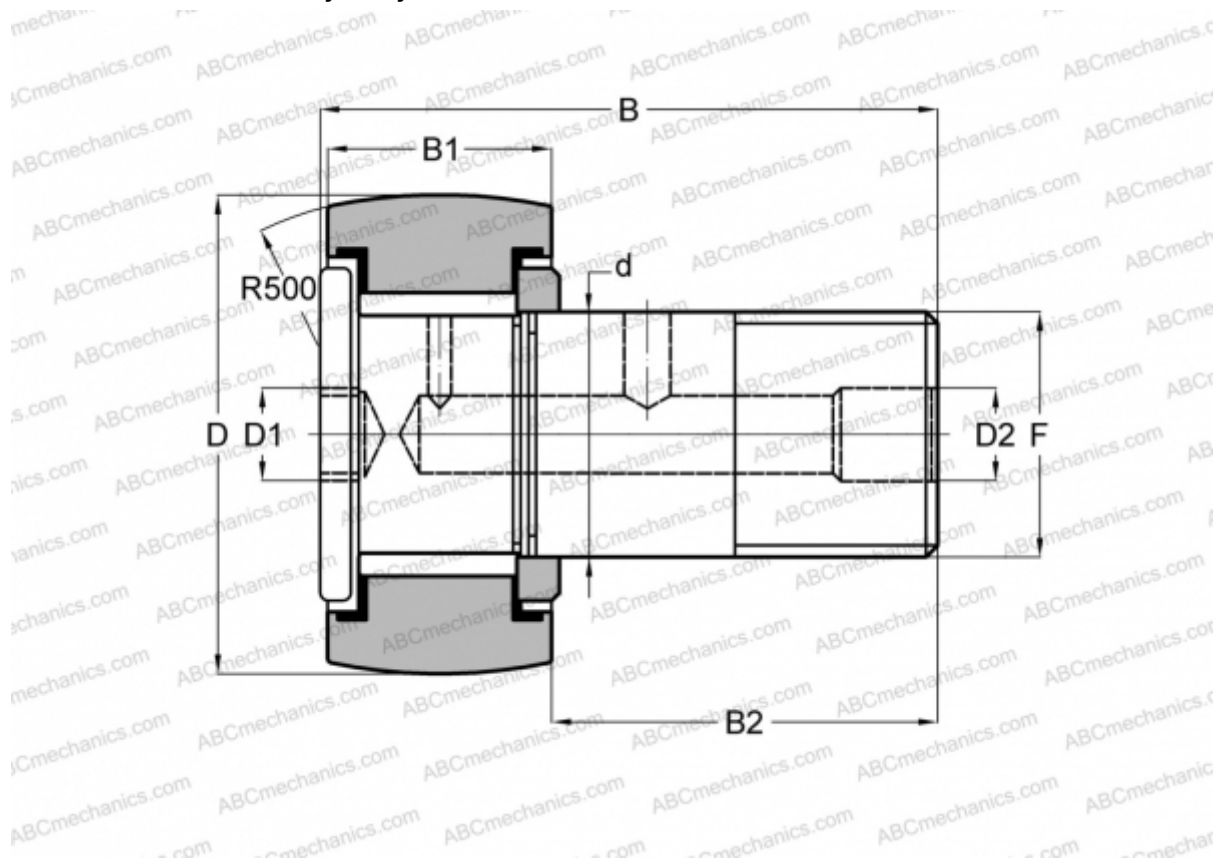

Technical specification

DIMENSIONS, MM

d	28,575
D	57,150
B	85,090
B1	34,200
B2	50,890
F	1 1/8-12

WEIGHT, KG 0,858

MANUFACTURER [ABC](#)

INTERCHANGE

IKO	CRH 36 V(B)R
McGill	CFH 2 1/4 (B)