

CRH 44 V(B)R IKO

Cam followers

TYPE: Roller bearings, Stud type track rollers, With axial guidance, full complement bearing, gap seal on both side, hex socket, heavy duty, inch size

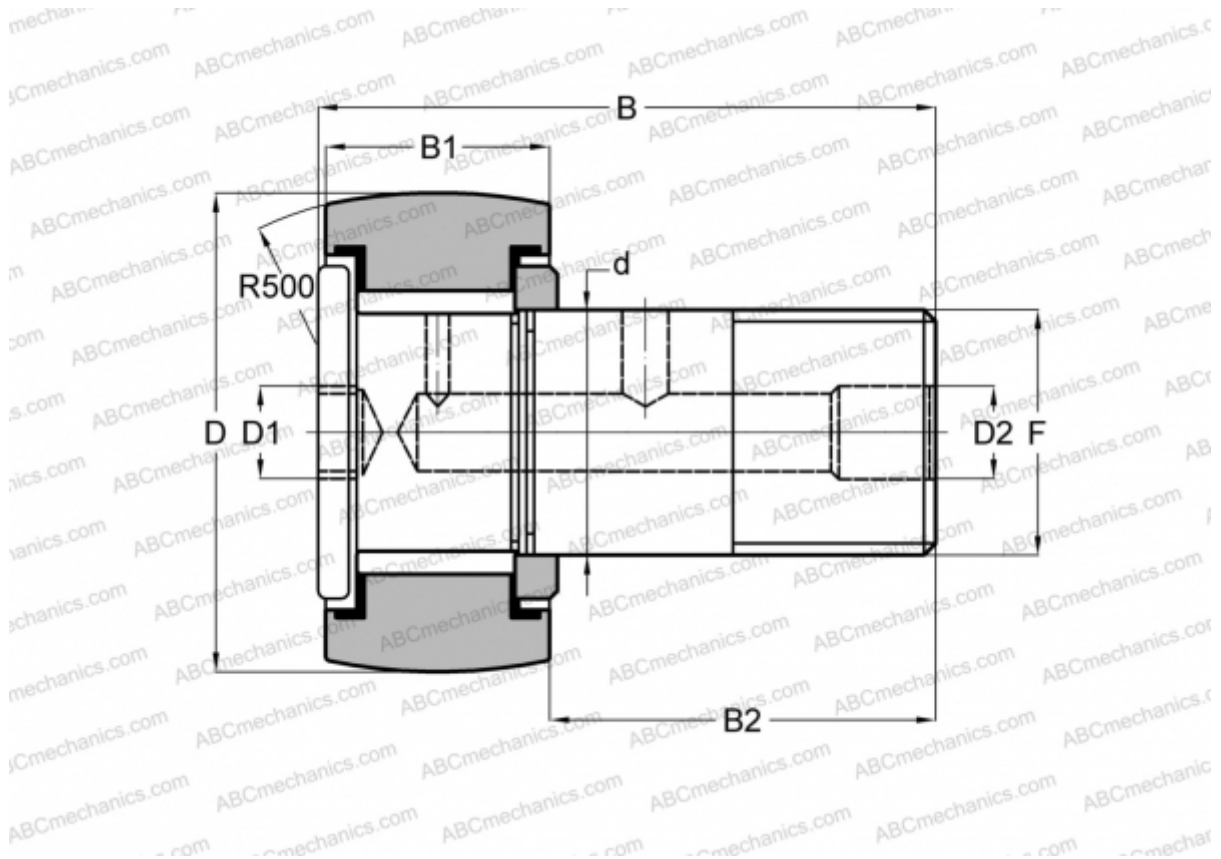

Technical specification

DIMENSIONS, MM

d	31,750
D	69,850
B	97,030
B1	40,000
B2	57,030
F	1 1/4-12

WEIGHT, KG 1,460

MANUFACTURER [IKO](#)

INTERCHANGE

ABC	CRH 44 V(B)R
McGill	CFH 2 3/4 (B)

CALCULATION DATA

Basic dynamic load rating, C	61,400 kN
------------------------------	-----------

CALCULATION DATA

Basic static load rating, Co	116,000 kN
------------------------------	------------