

CRH 8-1 V(B) IKO

Cam followers

TYPE: Roller bearings, Stud type track rollers, With axial guidance, full complement bearing, gap seal on both side, cylindrical outer ring, hex socket, heavy duty, inch size

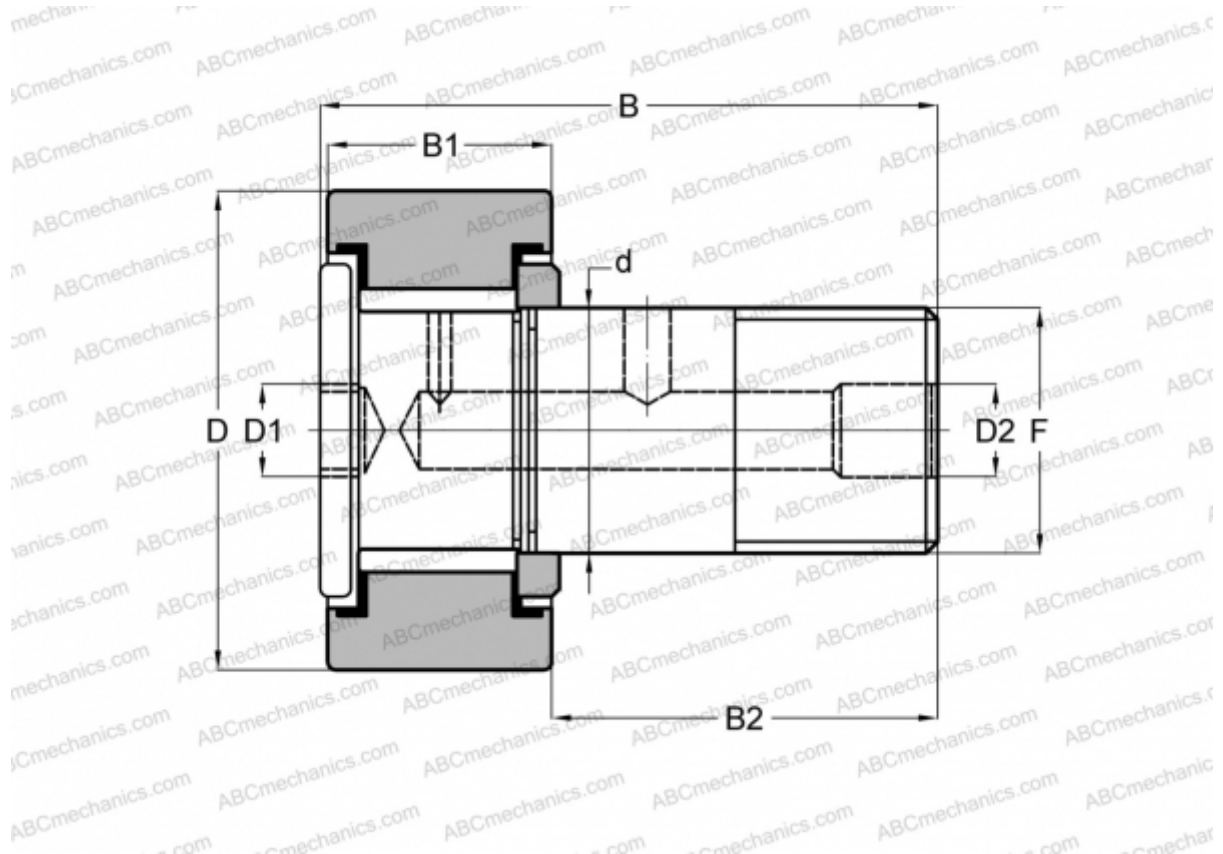

Technical specification

DIMENSIONS, MM

d	6,350
D	12,700
B	27,050
B1	11,100
B2	15,950
F	1/4-28

WEIGHT, KG 0,012

MANUFACTURER [IKO](#)

INTERCHANGE

ABC	CRH 8-1 V(B)
McGill	CFH 1/2 (B)

CALCULATION DATA

Basic dynamic load rating, C	4,710 kN
------------------------------	----------

CALCULATION DATA

Basic static load rating, Co	5,410 kN
------------------------------	----------