

## CFH 1/2 (B) McGill

Cam followers

TYPE: Roller bearings, Stud type track rollers, With axial guidance, full complement bearing, gap seal on both side, cylindrical outer ring, hex socket, heavy duty, inch size

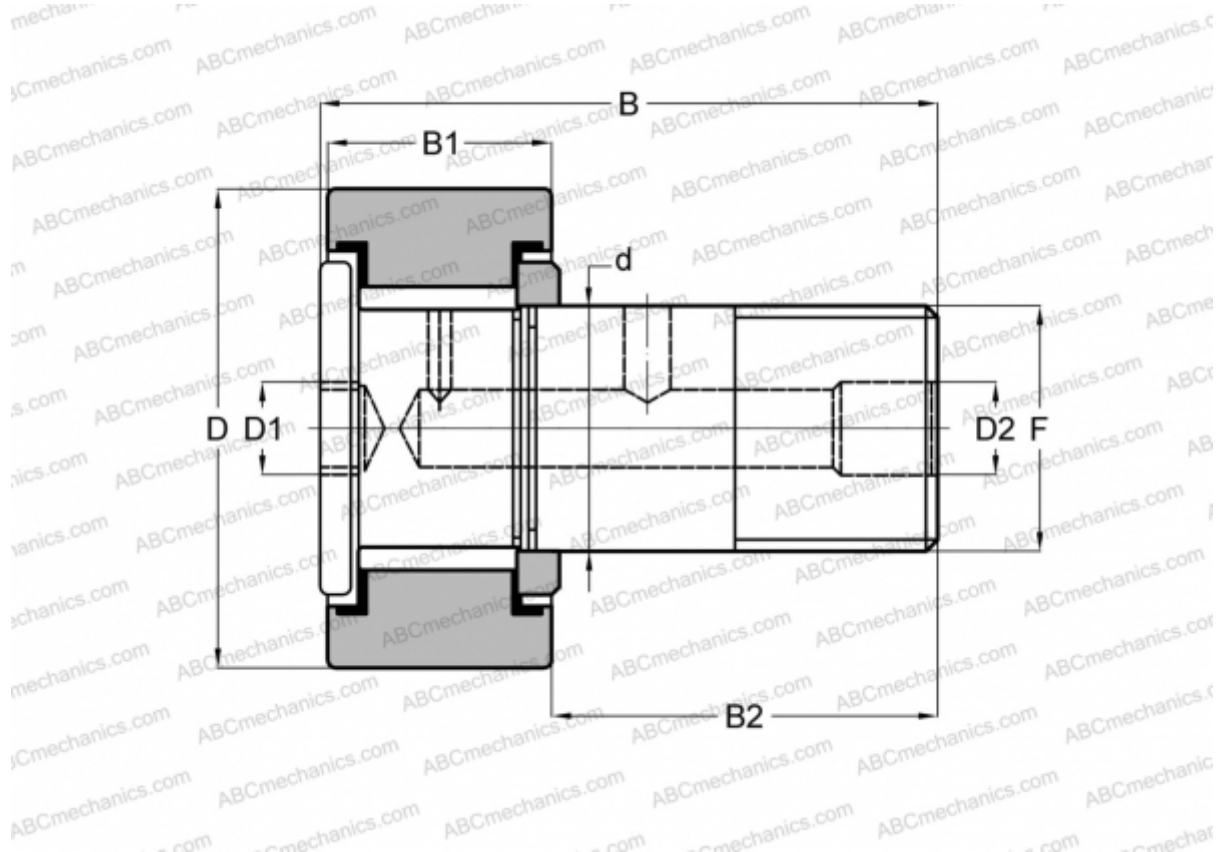

### Technical specification

#### DIMENSIONS, MM

d	6,350
D	12,700
B	27,050
B1	11,100
B2	15,950
F	1/4-28

**WEIGHT, KG** 0,012

**MANUFACTURER** [McGill](#)

#### INTERCHANGE

ABC	<a href="#">CRH 8-1 V(B)</a>
IKO	<a href="#">CRH 8-1 V(B)</a>