

CRH 9 V(B) ABC

Cam followers

TYPE: Roller bearings, Stud type track rollers, With axial guidance, full complement bearing, gap seal on both side, cylindrical outer ring, hex socket, heavy duty, inch size

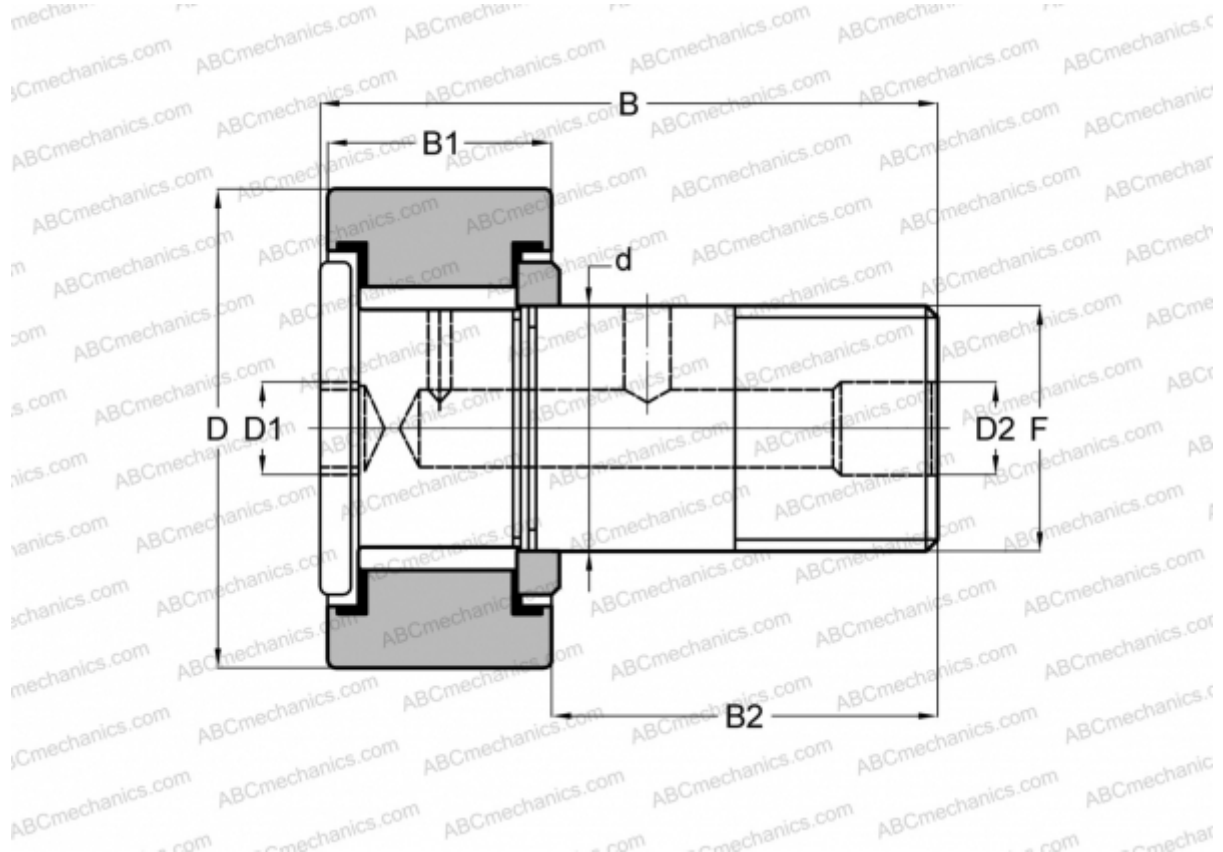

Technical specification

DIMENSIONS, MM

d	6,350
D	14,288
B	27,050
B1	11,100
B2	15,950
F	1/4-28

WEIGHT, KG 0,015

MANUFACTURER [ABC](#)

INTERCHANGE

IKO	CRH 9 V(B)
McGill	CFH 9/16 (B)