

CRH 14 V(B) IKO

Cam followers

TYPE: Roller bearings, Stud type track rollers, With axial guidance, full complement bearing, gap seal on both side, cylindrical outer ring, hex socket, heavy duty, inch size

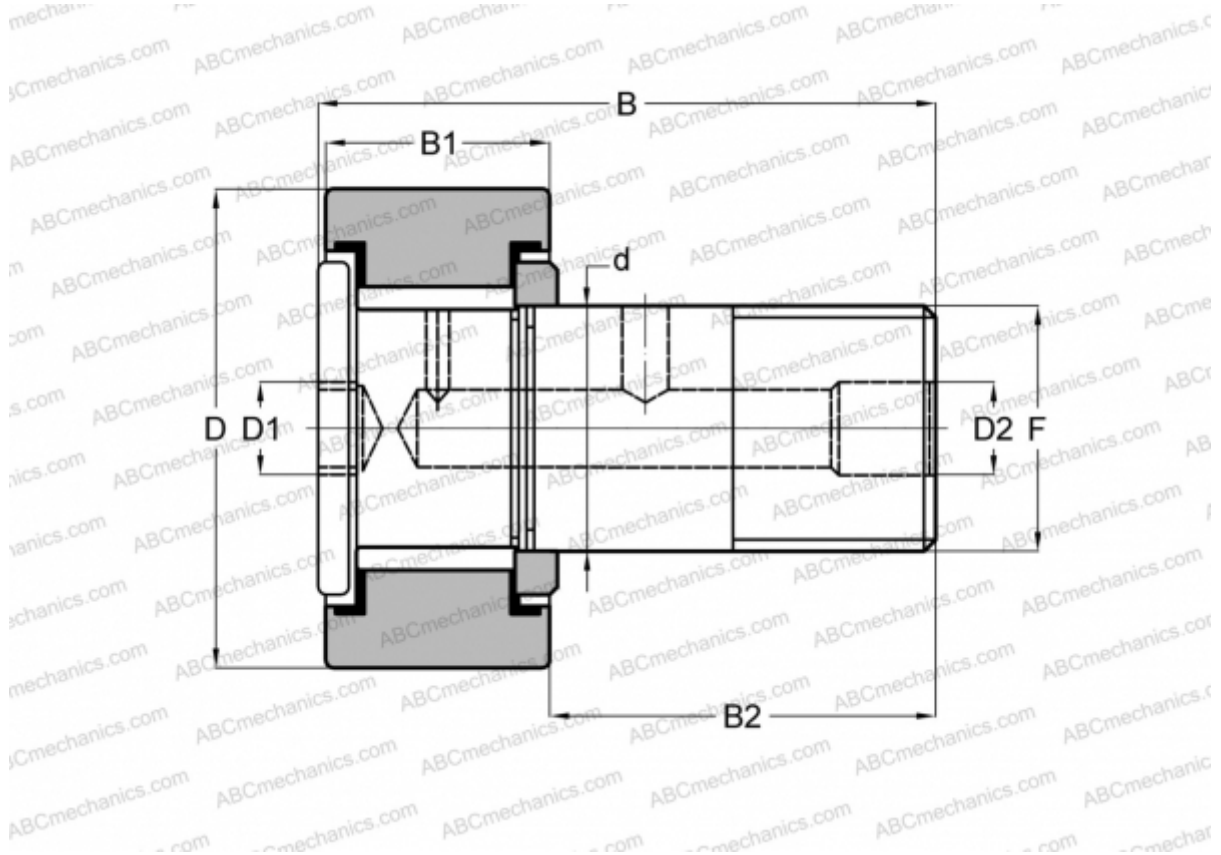

Technical specification

DIMENSIONS, MM

d	11,112
D	22,225
B	36,700
B1	14,600
B2	22,100
F	7/16-20

WEIGHT, KG 0,049

MANUFACTURER [IKO](#)

INTERCHANGE

ABC	CRH 14 V(B)
McGill	CFH 7/8 (B)

CALCULATION DATA

Basic dynamic load rating, C	8,710 kN
------------------------------	----------

CALCULATION DATA

Basic static load rating, Co	12,300 kN
------------------------------	-----------