

CFH 1 1/8 (B) McGill

Cam followers

TYPE: Roller bearings, Stud type track rollers, With axial guidance, full complement bearing, gap seal on both side, cylindrical outer ring, hex socket, heavy duty, inch size

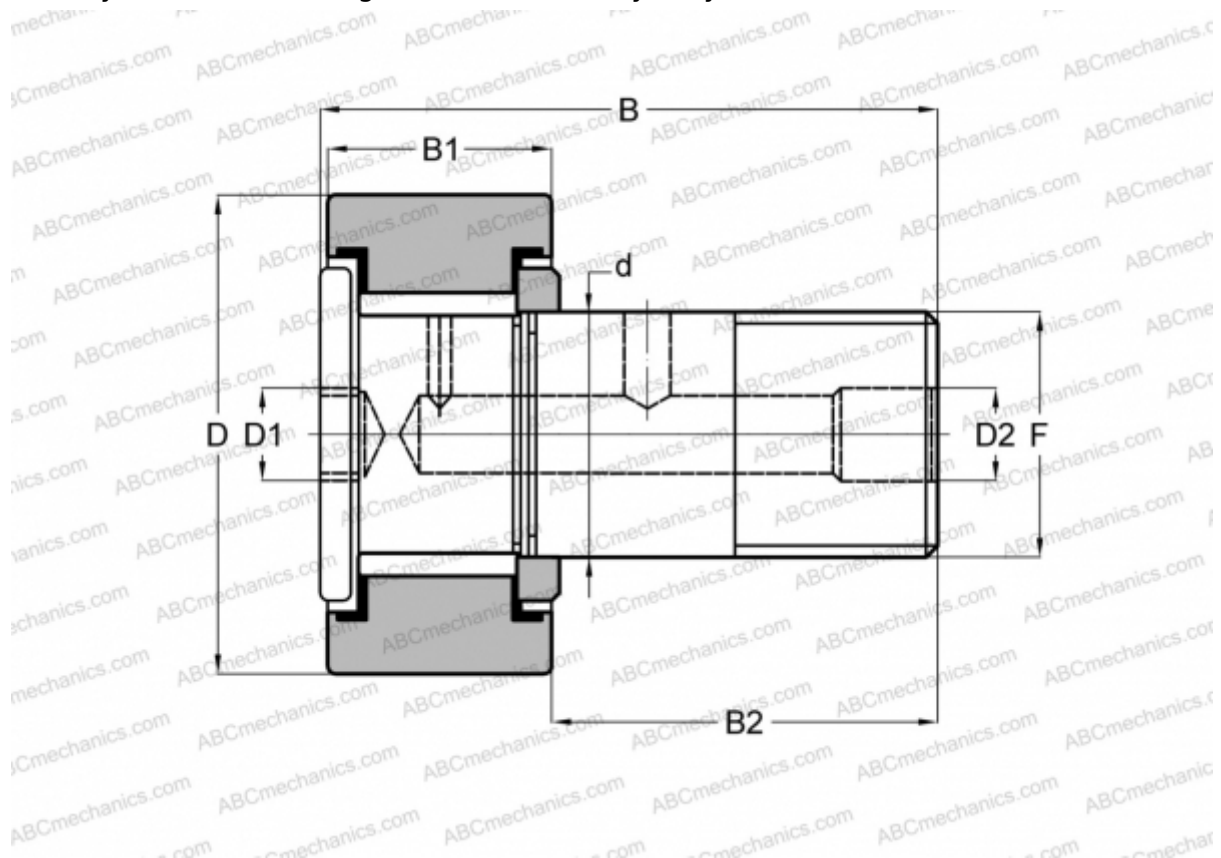

Technical specification

DIMENSIONS, MM

d	15,875
D	28,575
B	43,180
B1	17,900
B2	25,280
F	5/8-18

WEIGHT, KG 0,109

MANUFACTURER [McGill](#)

INTERCHANGE

ABC	CRH 18 V(B)
IKO	CRH 18 V(B)