

CFH 1 3/4 (B) McGill

Cam followers

TYPE: Roller bearings, Stud type track rollers, With axial guidance, full complement bearing, gap seal on both side, cylindrical outer ring, hex socket, heavy duty, inch size

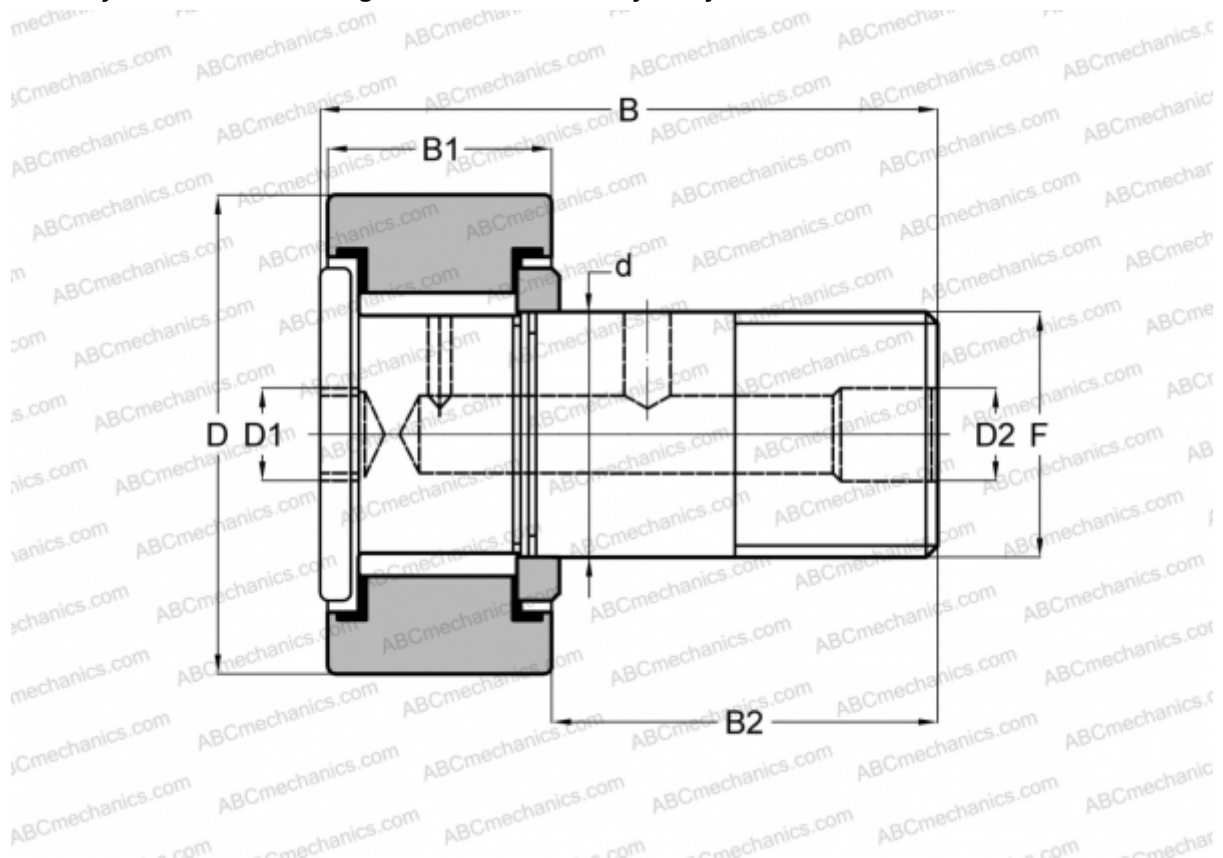

Technical specification

DIMENSIONS, MM

d	25,400
D	44,450
B	71,880
B1	27,400
B2	44,480
F	1-14UNS

WEIGHT, KG 0,463

MANUFACTURER [McGill](#)

INTERCHANGE

ABC	CRH 28 V(B)
IKO	CRH 28 V(B)