

## CRH 9 V(B)UUR IKO

Cam followers

TYPE: Roller bearings, Stud type track rollers, With axial guidance, full complement bearing, sealing rings on both sides, hex socket, heavy duty, inch size

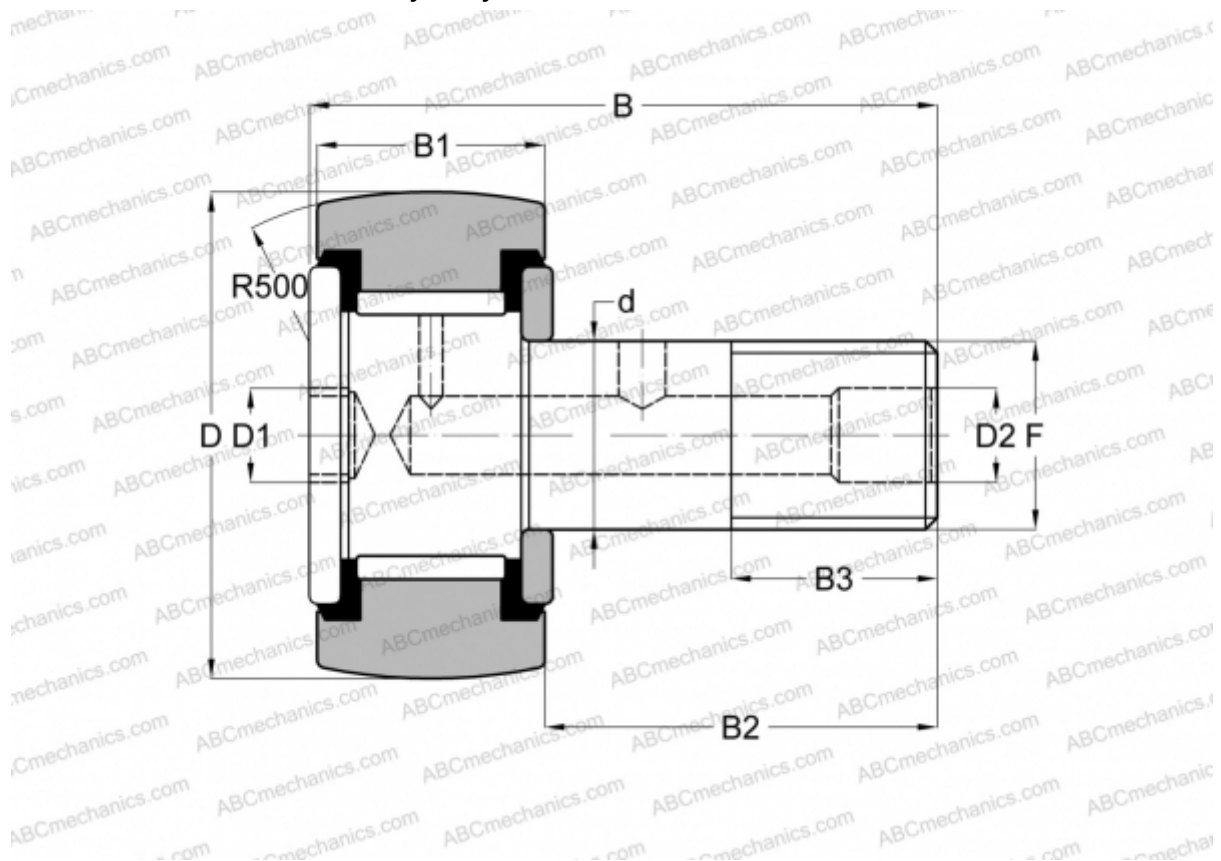

### Technical specification

#### DIMENSIONS, MM

d	6,350
D	14,288
B	27,050
B1	11,100
B2	15,950
F	1/4-28

**WEIGHT, KG** 0,015

**MANUFACTURER** [IKO](#)

#### INTERCHANGE

ABC	<a href="#">CRH 9 V(B)UUR</a>
McGill	<a href="#">CCFH 9/16 S(B)</a>

#### CALCULATION DATA

Basic dynamic load rating, C	4,710 kN
------------------------------	----------

#### CALCULATION DATA

Basic static load rating, Co	5,410 kN
------------------------------	----------