

CRH 18 V(B)UUR IKO

Cam followers

TYPE: Roller bearings, Stud type track rollers, With axial guidance, full complement bearing, sealing rings on both sides, hex socket, heavy duty, inch size

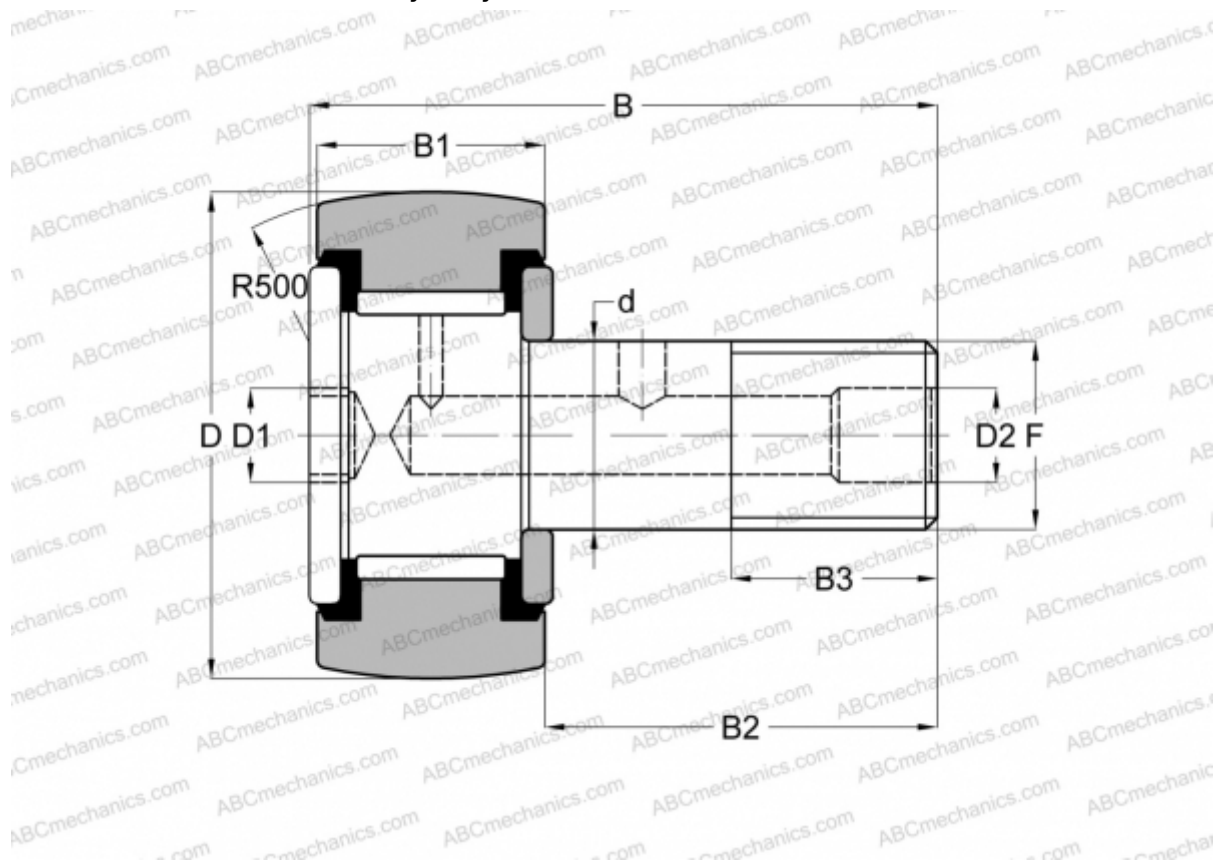

Technical specification

DIMENSIONS, MM

d	15,875
D	28,575
B	43,180
B1	17,900
B2	25,280
F	5/8-18

WEIGHT, KG 0,109

MANUFACTURER [IKO](#)

INTERCHANGE

ABC	CRH 18 V(B)UUR
McGill	CCFH 1 1/8 S(B)

CALCULATION DATA

Basic dynamic load rating, C	13,100 kN
------------------------------	-----------

CALCULATION DATA

Basic static load rating, Co	22,700 kN
------------------------------	-----------