

CCFH 1 3/8 S(B) McGill

Cam followers

TYPE: Roller bearings, Stud type track rollers, With axial guidance, full complement bearing, sealing rings on both sides, hex socket, heavy duty, inch size

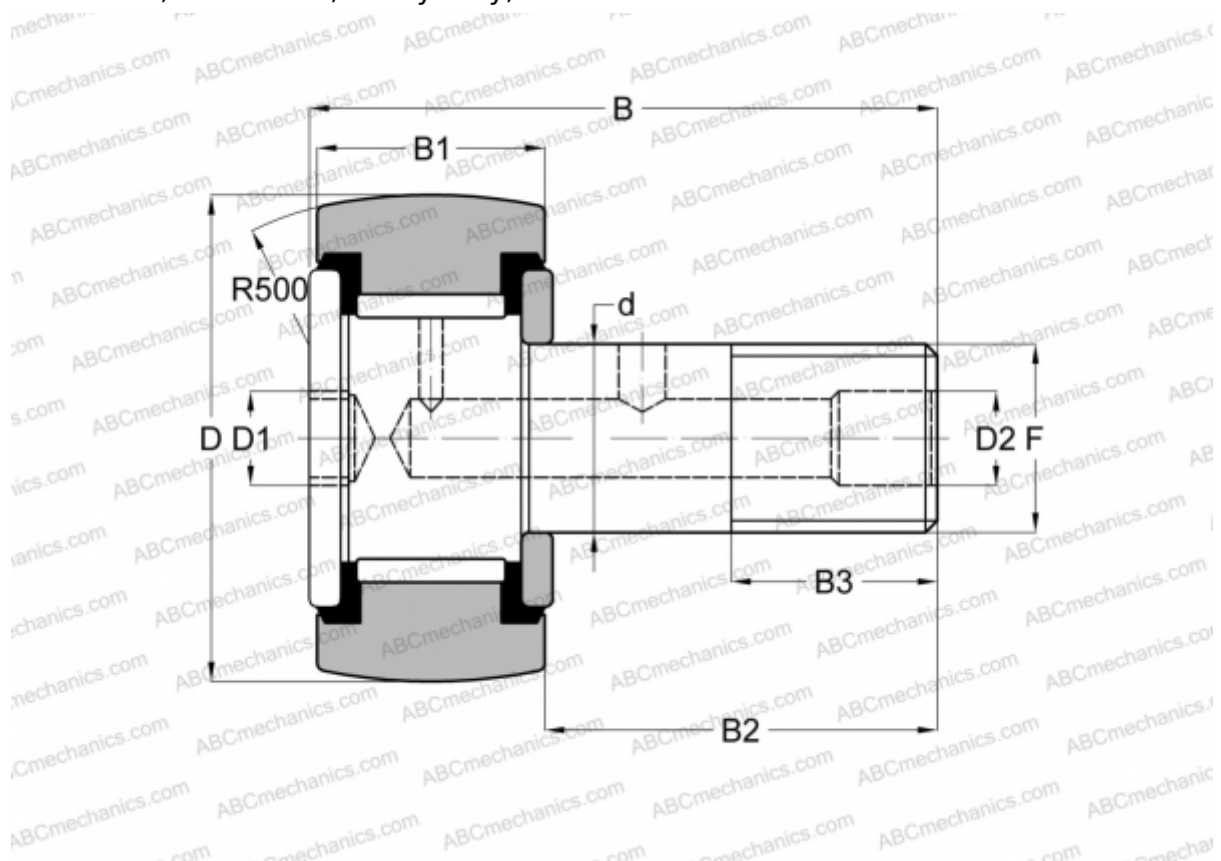

Technical specification

DIMENSIONS, MM

d	19,050
D	34,925
B	49,660
B1	21,000
B2	28,660
F	3/4-16

WEIGHT, KG 0,200

MANUFACTURER [McGill](#)

INTERCHANGE

ABC	CRH 22 V(B)UUR
IKO	CRH 22 V(B)UUR