

CRH 30 V(B)UUR IKO

Cam followers

TYPE: Roller bearings, Stud type track rollers, With axial guidance, full complement bearing, sealing rings on both sides, hex socket, heavy duty, inch size

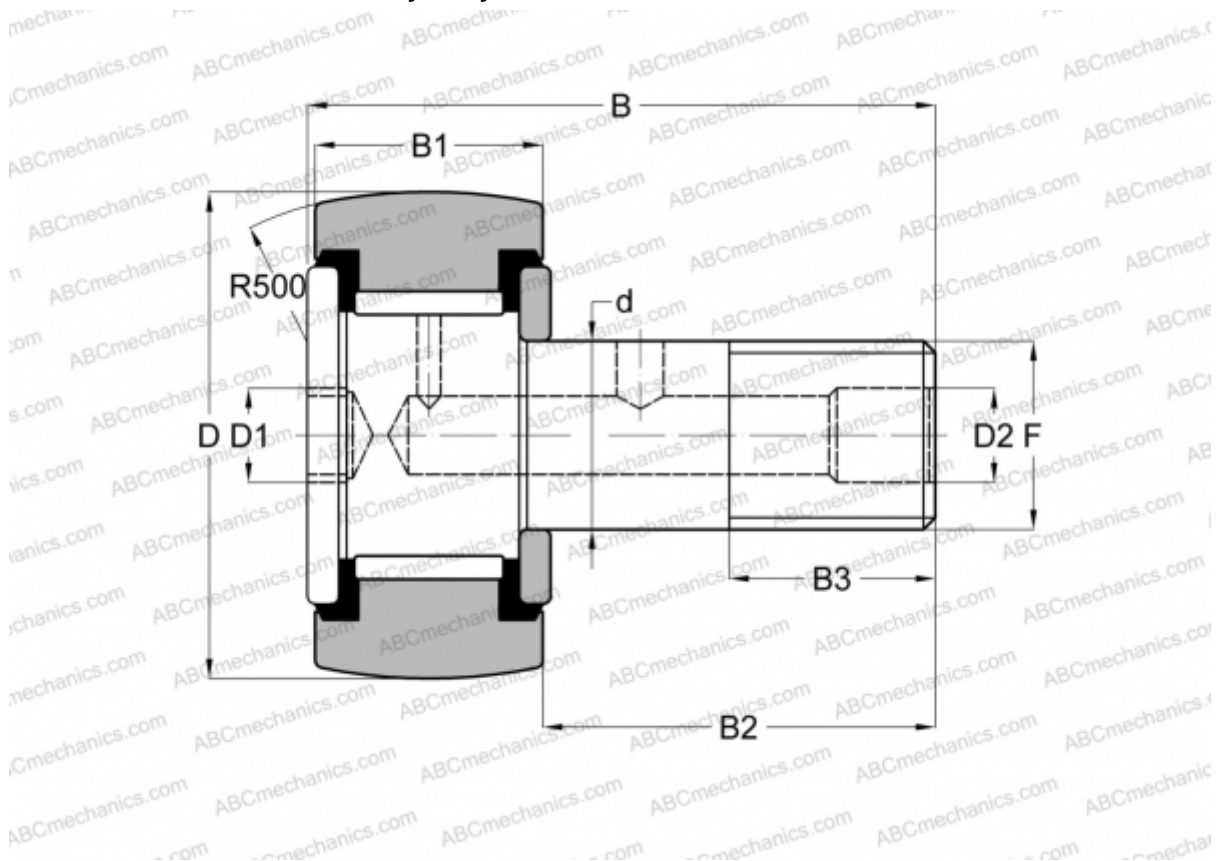

Technical specification

DIMENSIONS, MM

d	25,400
D	47,625
B	71,880
B1	27,400
B2	44,480
F	1-14UNS

WEIGHT, KG 0,508

MANUFACTURER [IKO](#)

INTERCHANGE

ABC	CRH 30 V(B)UUR
McGill	CCFH 1 7/8 S(B)

CALCULATION DATA

Basic dynamic load rating, C	35,300 kN
------------------------------	-----------

CALCULATION DATA

Basic static load rating, Co	55,600 kN
------------------------------	-----------