

CRH 8-1 V(B)UU ABC

Cam followers

TYPE: Roller bearings, Stud type track rollers, With axial guidance, full complement bearing, sealing rings on both sides, cylindrical outer ring, heavy duty, inch size

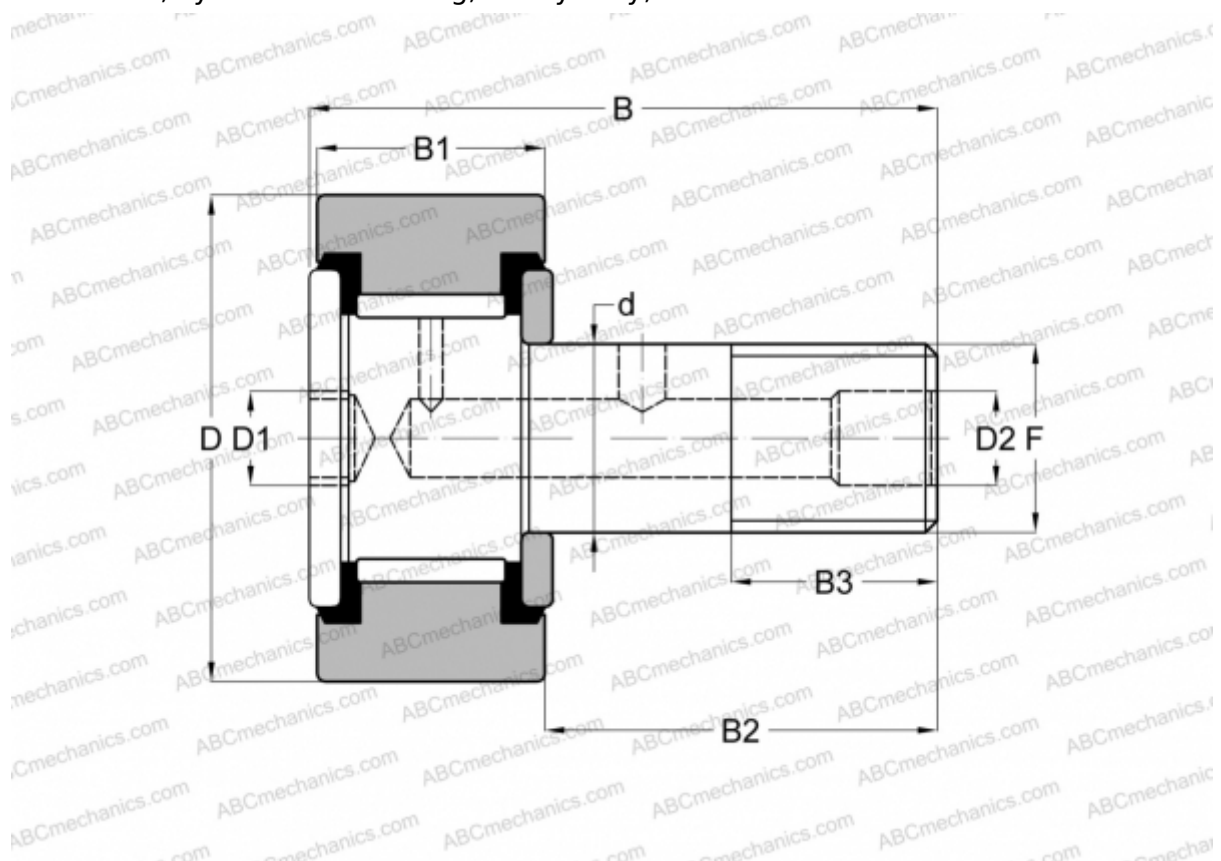

Technical specification

DIMENSIONS, MM

d	6,350
D	12,700
B	27,050
B1	11,100
B2	15,950
F	1/4-28

WEIGHT, KG 0,012

MANUFACTURER [ABC](#)

INTERCHANGE

IKO	CRH 8-1 V(B)UU
McGill	CFH 1/2 S(B)