

## CRH 8-1 V(B)UU IKO

Cam followers

TYPE: Roller bearings, Stud type track rollers, With axial guidance, full complement bearing, sealing rings on both sides, cylindrical outer ring, heavy duty, inch size

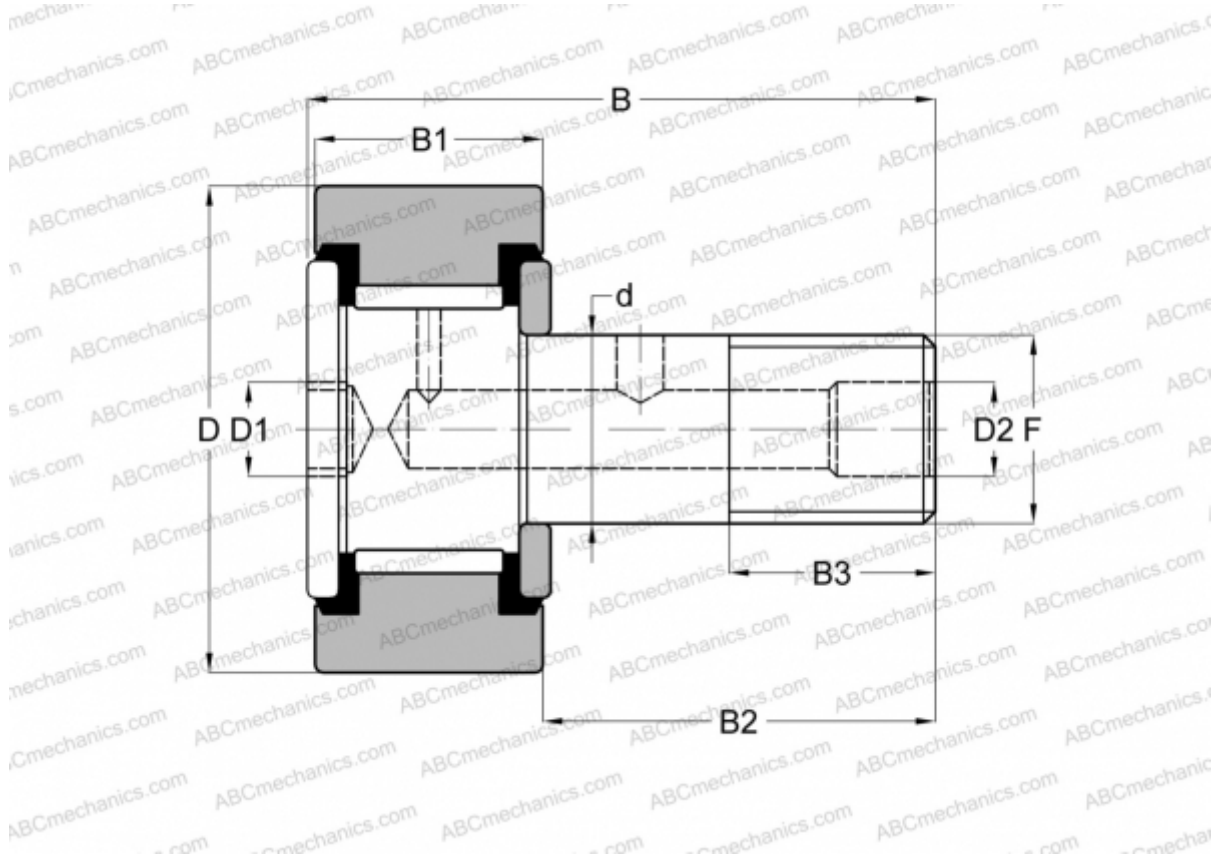

### Technical specification

#### DIMENSIONS, MM

d	6,350
D	12,700
B	27,050
B1	11,100
B2	15,950
F	1/4-28

**WEIGHT, KG** 0,012

**MANUFACTURER** [IKO](#)

#### INTERCHANGE

ABC	<a href="#">CRH 8-1 V(B)UU</a>
McGill	<a href="#">CFH 1/2 S(B)</a>

#### CALCULATION DATA

Basic dynamic load rating, C	4,710 kN
------------------------------	----------

#### CALCULATION DATA

Basic static load rating, Co	5,410 kN
------------------------------	----------