

STO 17(NAST 17 DB) FAG

Yoke type track roller

TYPE: Roller bearings, Yoke type track rollers, Without axial guidance, With an inner ring, Outer ring without ribs

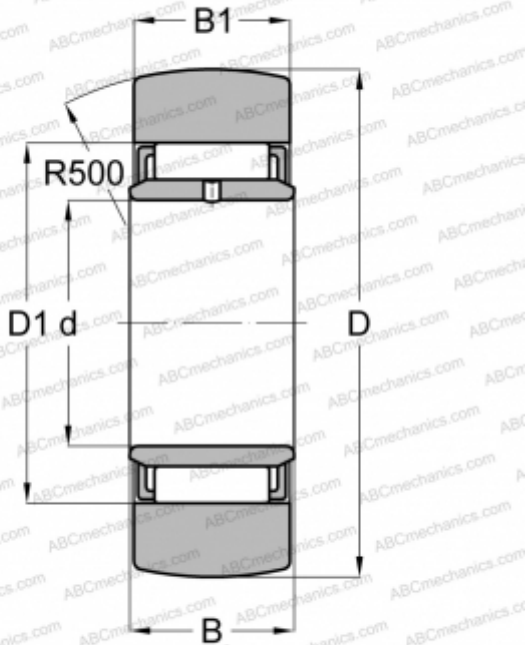

Technical specification

DIMENSIONS, MM

d	17,000
D	40,000
D1	29,000
B	16,000
B1	15,800

WEIGHT, KG

0,118

MANUFACTURER

[FAG](#)

INTERCHANGE

ABC	STO 17
INA	STO 17
SKF	STO 17
TORRINGTON	STO 17
IKO	NAST 17 R