

NATR 5 SKF

Yoke type track roller

TYPE: Roller bearings, Yoke type track rollers, With axial guidance, Gap seals on both side

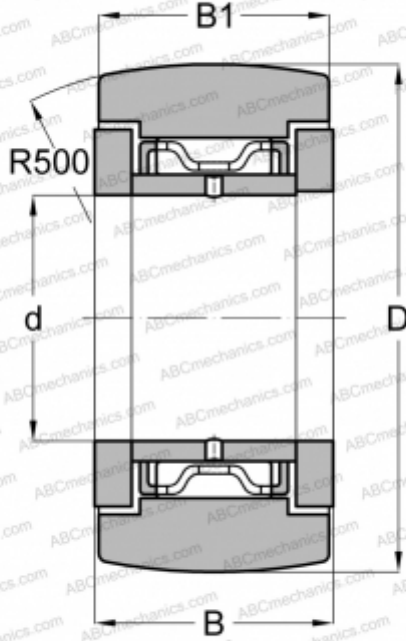

Technical specification

DIMENSIONS, MM

d	5,000
D	16,000
B	12,000
B1	11,000

WEIGHT, KG

0,014

MANUFACTURER

[SKF](#)

INTERCHANGE

ABC	NATR 5
FAG	NATR 5/ NATD 5
INA	NATR 5
IKO	NART 5 R
McGill	MCYRR-5

CALCULATION DATA

Basic dynamic load rating, C	3,140 kN
Basic static load rating, Co	3,200 kN
Fatigue load limit, Pu	0,345 kN
Limiting speed	6000 r/min