

NATR 6 R IKO

Yoke type track roller

TYPE: Roller bearings, Yoke type track rollers, With axial guidance, Gap seals on both side

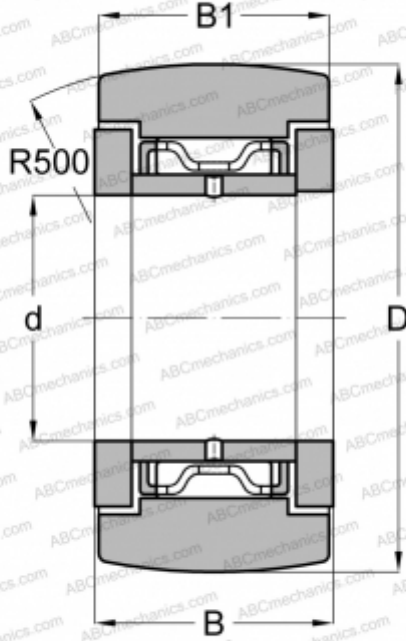

Technical specification

DIMENSIONS, MM

d	6,000
D	19,000
B	12,000
B1	11,000

WEIGHT, KG

0,021

MANUFACTURER

[IKO](#)

INTERCHANGE

ABC	NATR 6
FAG	NATR 6/ NATD 6
INA	NATR 6
McGill	MCYRR-6
SKF	NATR 6

CALCULATION DATA

Basic dynamic load rating, C	4,250 kN
Basic static load rating, Co	4,740 kN