

## NATR 15 SKF

Yoke type track roller

TYPE: Roller bearings, Yoke type track rollers, With axial guidance, Gap seals on both side

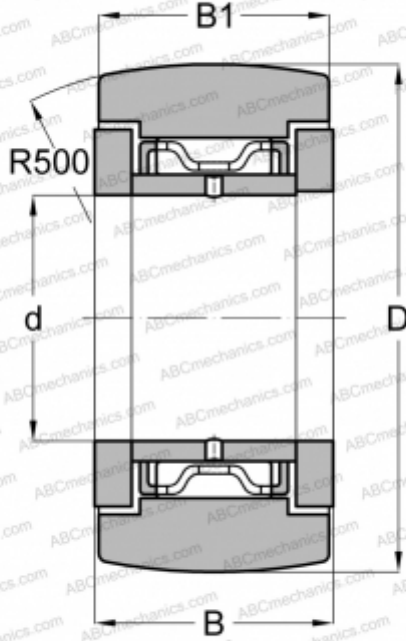

### Technical specification

#### DIMENSIONS, MM

d	15,000
D	35,000
B	19,000
B1	18,000

#### WEIGHT, KG

0,100

#### MANUFACTURER

[SKF](#)

#### INTERCHANGE

ABC	<a href="#">NATR 15</a>
INA	<a href="#">NATR 15</a>
IKO	<a href="#">NART 15 R</a>
McGill	<a href="#">MCYRR-15</a>

#### CALCULATION DATA

Basic dynamic load rating, C	9,520 kN
Basic static load rating, Co	13,700 kN
Fatigue load limit, Pu	1,560 kN
Limiting speed	4000 r/min