

NATR 17 R IKO

Yoke type track roller

TYPE: Roller bearings, Yoke type track rollers, With axial guidance, Gap seals on both side

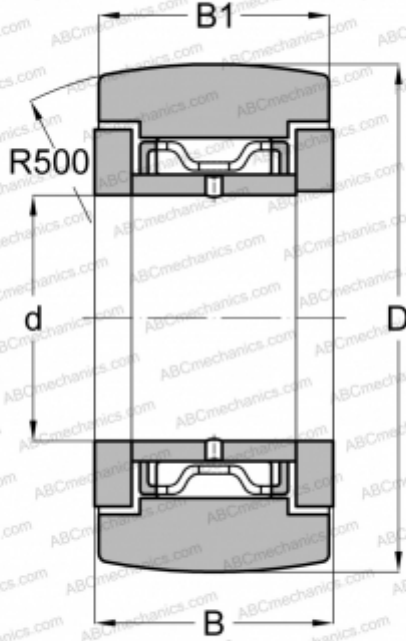

Technical specification

DIMENSIONS, MM

d	17,000
D	40,000
B	21,000
B1	20,000

WEIGHT, KG

0,149

MANUFACTURER

[IKO](#)

INTERCHANGE

ABC	NATR 17
INA	NATR 17
McGill	MCYRR-17
SKF	NATR 17

CALCULATION DATA

Basic dynamic load rating, C	17,600 kN
Basic static load rating, Co	21,000 kN