

NATR 20 SKF

Yoke type track roller

TYPE: Roller bearings, Yoke type track rollers, With axial guidance, Gap seals on both side

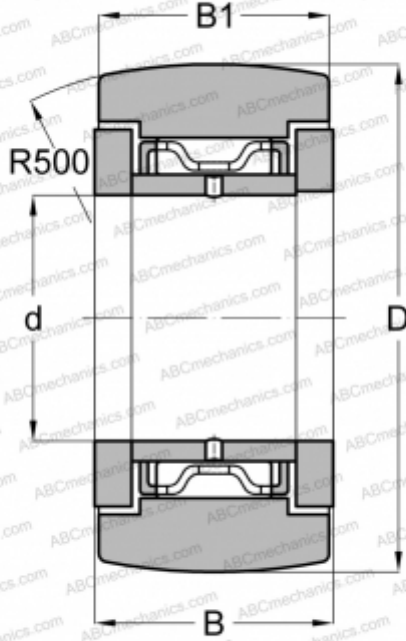

Technical specification

DIMENSIONS, MM

d	20,000
D	47,000
B	25,000
B1	24,000

WEIGHT, KG

0,250

MANUFACTURER

[SKF](#)

INTERCHANGE

ABC	NATR 20
INA	NATR 20
IKO	NART 20 R
McGill	MCYRR-20

CALCULATION DATA

Basic dynamic load rating, C	14,700 kN
Basic static load rating, Co	24,500 kN
Fatigue load limit, Pu	2,900 kN
Limiting speed	3000 r/min