

NATR 25 R IKO

Yoke type track roller

TYPE: Roller bearings, Yoke type track rollers, With axial guidance, Gap seals on both side

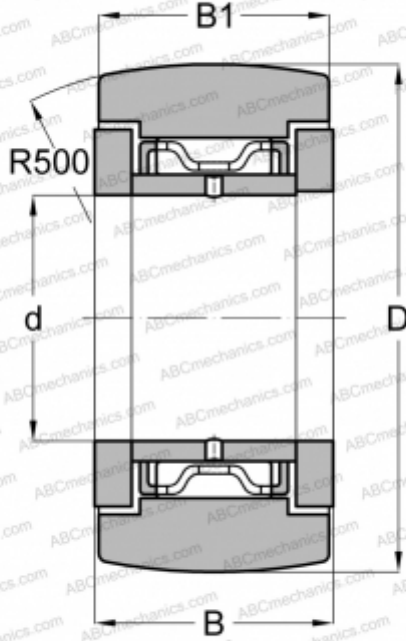

Technical specification

DIMENSIONS, MM

d	25,000
D	52,000
B	25,000
B1	24,000

WEIGHT, KG

0,285

MANUFACTURER

[IKO](#)

INTERCHANGE

ABC	NATR 25
INA	NATR 25
McGill	MCYRR-25
SKF	NATR 25

CALCULATION DATA

Basic dynamic load rating, C	24,700 kN
Basic static load rating, Co	35,400 kN