

NATR 30 R IKO

Yoke type track roller

TYPE: Roller bearings, Yoke type track rollers, With axial guidance, Gap seals on both side

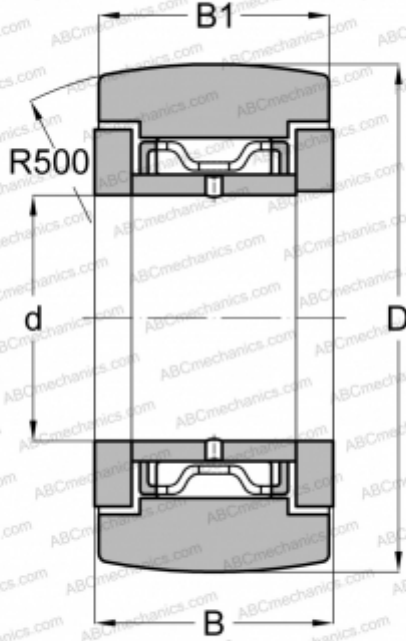

Technical specification

DIMENSIONS, MM

d	30,000
D	62,000
B	29,000
B1	28,000

WEIGHT, KG

0,470

MANUFACTURER

[IKO](#)

INTERCHANGE

ABC	NATR 30
INA	NATR 30
McGill	MCYRR-30
SKF	NATR 30

CALCULATION DATA

Basic dynamic load rating, C	33,600 kN
Basic static load rating, Co	51,400 kN