

NATR 45 R IKO

Yoke type track roller

TYPE: Roller bearings, Yoke type track rollers, With axial guidance, Gap seals on both side

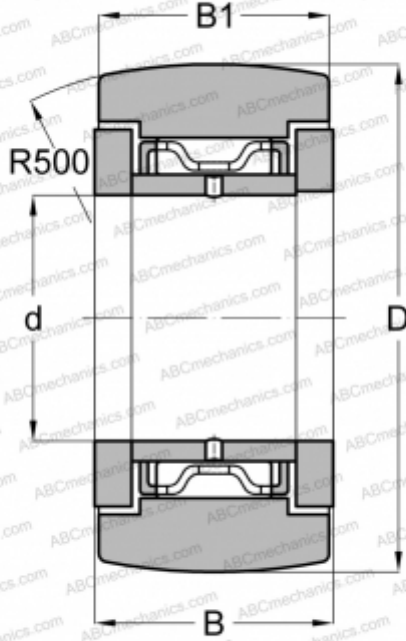

Technical specification

DIMENSIONS, MM

d	45,000
D	85,000
B	32,000
B1	30,000

WEIGHT, KG

0,915

MANUFACTURER

[IKO](#)

INTERCHANGE

ABC	NATR 45
McGill	MCYRR-45
SKF	NATR 45

CALCULATION DATA

Basic dynamic load rating, C	46,800 kN
Basic static load rating, Co	88,600 kN