

NATR 50 R IKO

Yoke type track roller

TYPE: Roller bearings, Yoke type track rollers, With axial guidance, Gap seals on both side

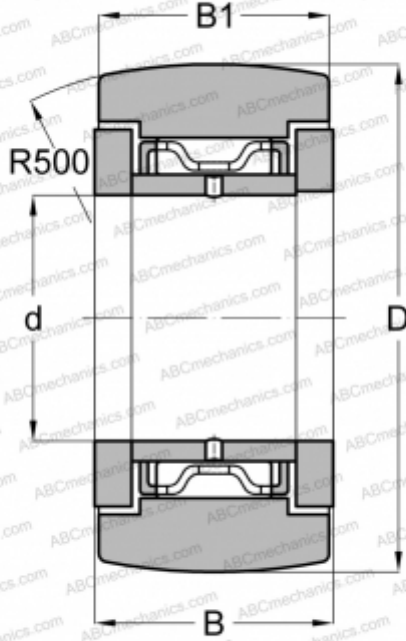

Technical specification

DIMENSIONS, MM

d	50,000
D	90,000
B	32,000
B1	30,000

WEIGHT, KG

0,980

MANUFACTURER

[IKO](#)

INTERCHANGE

ABC	NATR 50
McGill	MCYRR-50
SKF	NATR 50

CALCULATION DATA

Basic dynamic load rating, C	48,600 kN
Basic static load rating, Co	95,600 kN