

NATR 5 PPA SKF

Yoke type track roller

TYPE: Roller bearings, Yoke type track rollers, With axial guidance, Sealing rings on both sides

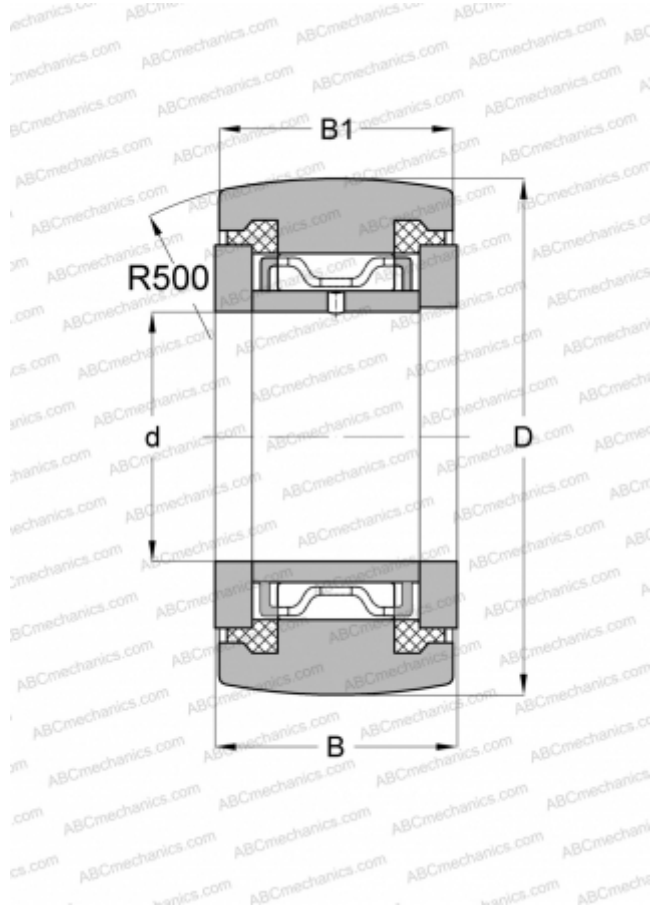

Technical specification

DIMENSIONS, MM

d	5,000
D	16,000
B	12,000
B1	11,000

WEIGHT, KG

0,014

MANUFACTURER

[SKF](#)

INTERCHANGE

ABC	NATR 5 PP
INA	NATR 5 PP
IKO	NART 5 UUR
McGill	MCYRR-5-S

CALCULATION DATA

Basic dynamic load rating, C	3,140 kN
Basic static load rating, Co	3,200 kN
Fatigue load limit, Pu	0,345 kN
Limiting speed	6000 r/min