

NART 8 UUR IKO

Yoke type track roller

TYPE: Roller bearings, Yoke type track rollers, With axial guidance, Sealing rings on both sides

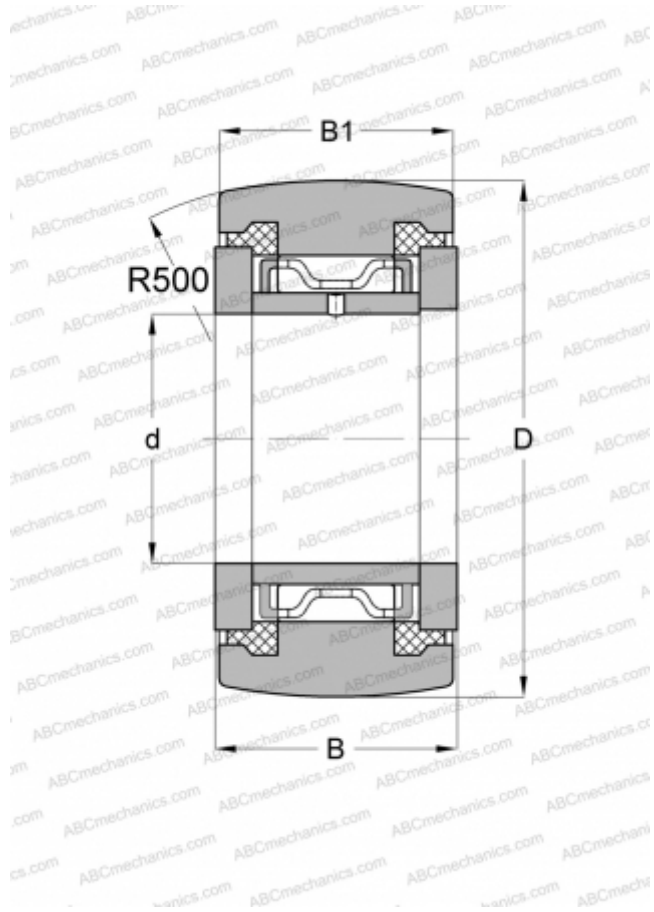

Technical specification

DIMENSIONS, MM

d	8,000
D	24,000
B	15,000
B1	14,000

WEIGHT, KG

0,042

MANUFACTURER

[IKO](#)

INTERCHANGE

ABC	NATR 8 PP
INA	NATR 8 PP
SKF	NATR 8 PPA
McGill	MCYRR-8-S

CALCULATION DATA

Basic dynamic load rating, C	5,640 kN
Basic static load rating, Co	5,900 kN