

NATR 10 PP ABC

Yoke type track roller

TYPE: Roller bearings, Yoke type track rollers, With axial guidance, Sealing rings on both sides

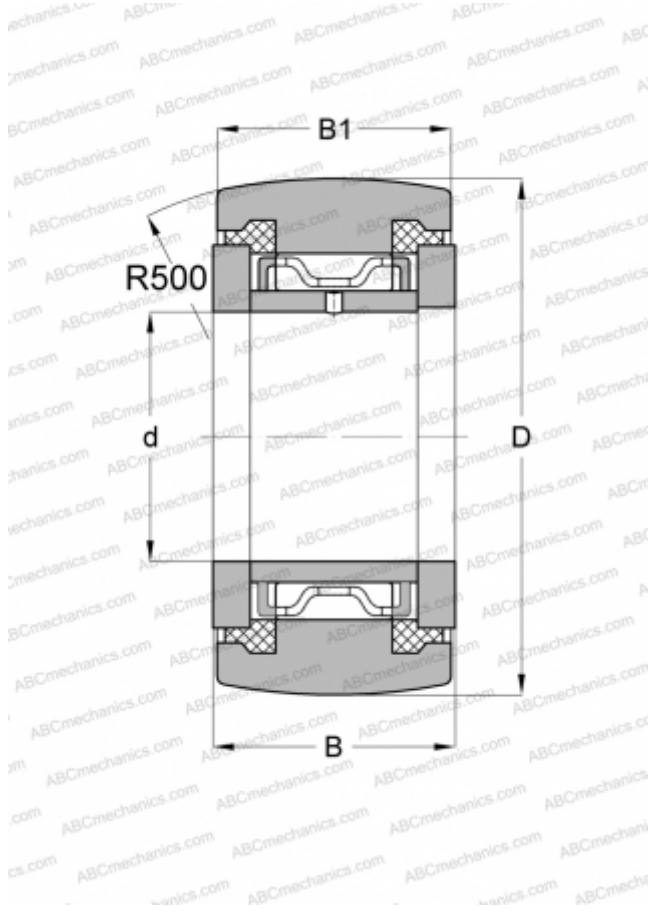

Technical specification

DIMENSIONS, MM

d	10,000
D	30,000
B	15,000
B1	14,000

WEIGHT, KG

0,068

MANUFACTURER

[ABC](#)

INTERCHANGE

INA	NATR 10 PP
SKF	NATR 10 PPA
IKO	NART 10 UUR
McGill	MCYRR-10-S